

















# ASSEMBLY INSTRUCTION

Carton 1/2: contains Part A and B

Carton 2/2: containers Part C-Q

Item NO: Denver

## HARDWARE LIST

NO.	PART	DESCRIPTION	Q'TY	NO.	PART	DESCRIPTION	Q'TY
A		Glass top	1	J		Hexagon spanner M8	1
B		Glass bottom	1	K		Screw nut M8	4
C		Base	1	L		Caps M8x18mm	4
D		Frame	3	M		Nail M4x40mm	3
E		Vertical Frame	1	N		Screw M8x20mm	3
F		ROD M8X255mm	1	O		Allen key 5#	1
G		Aluminum plate M58	3	P		Long allen key 3#	1
H		Short Thread M6x8mm	6	Q		wrench	1
I		Long Thread M8x60mm	3				

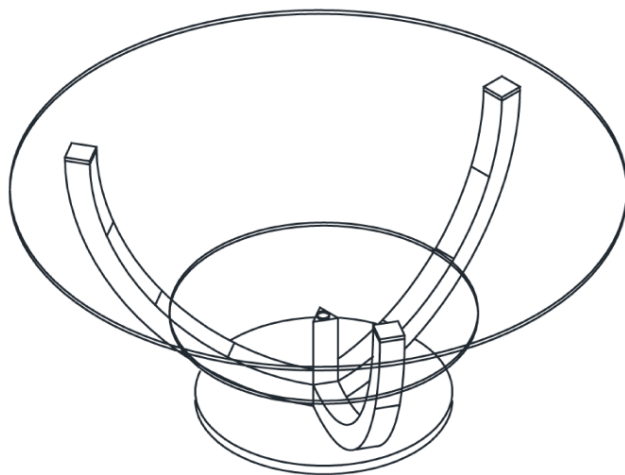

### Step 1

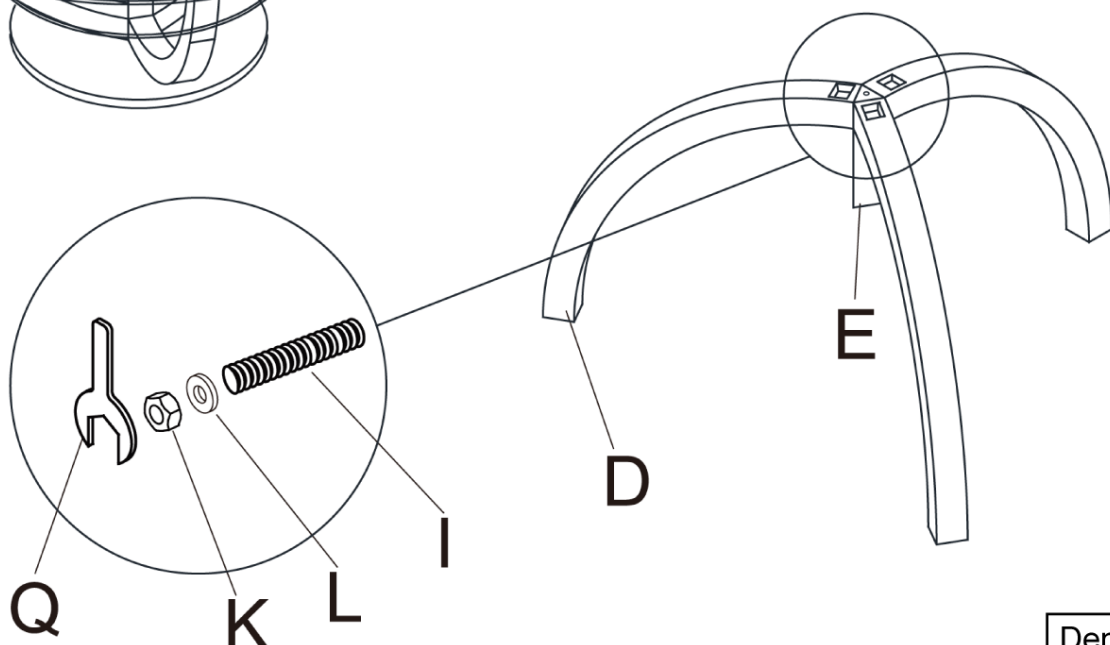

Step 2

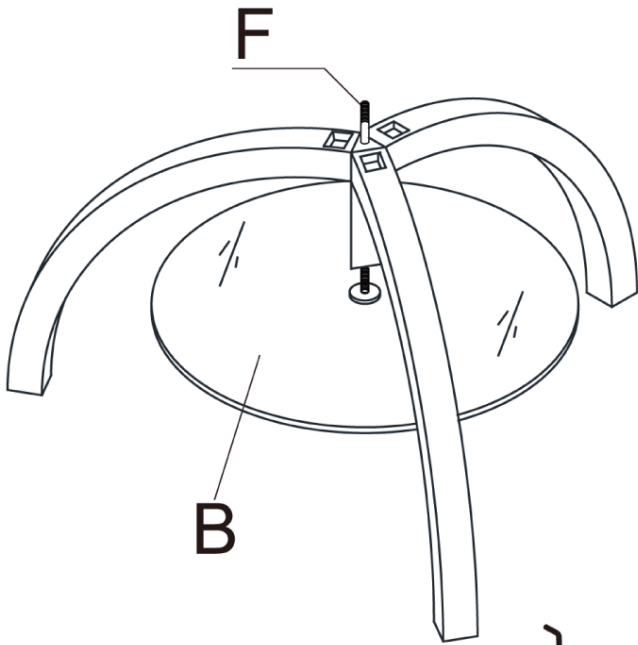

Step 3

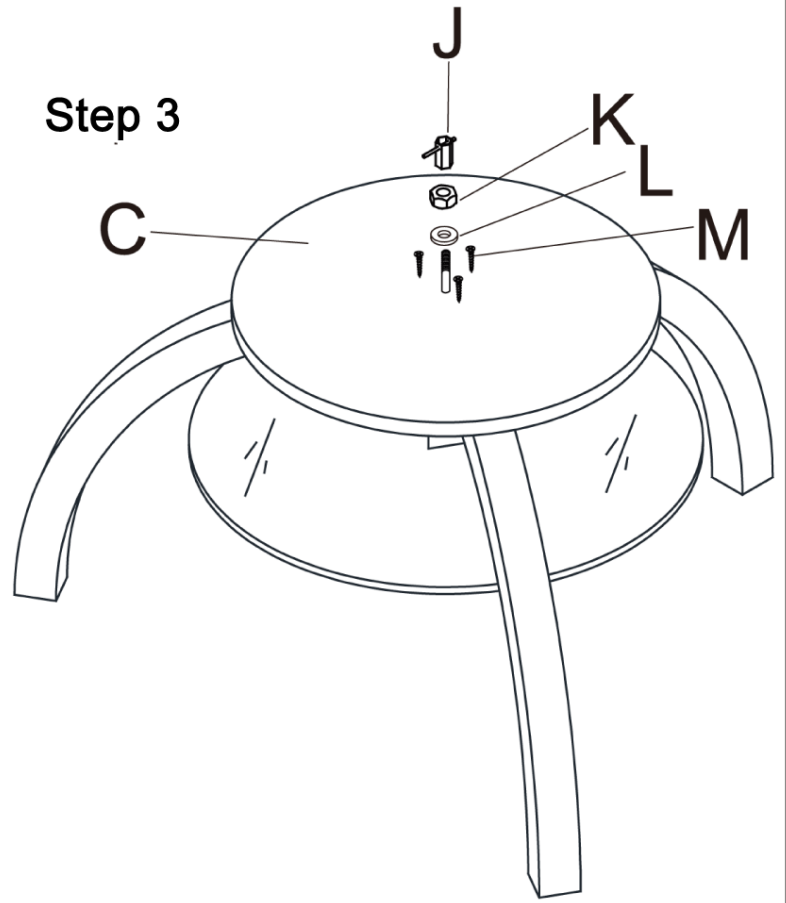

Step 4

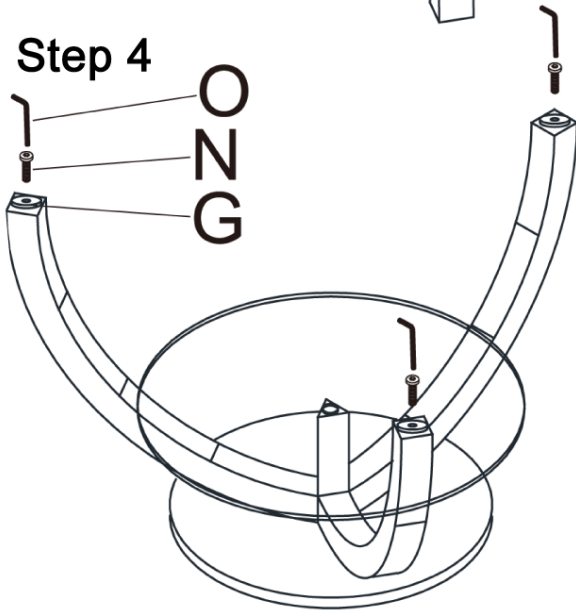

Step 5

