

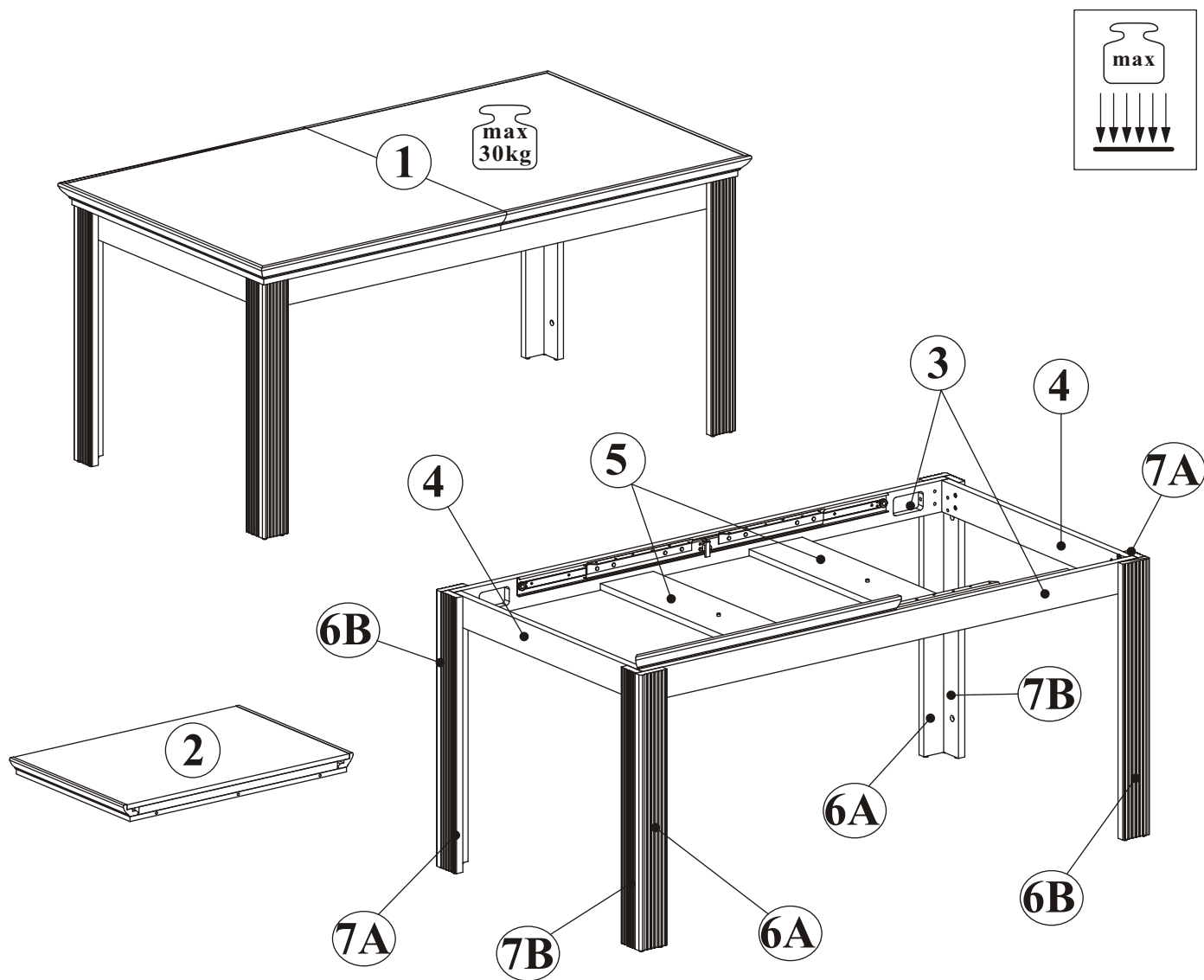

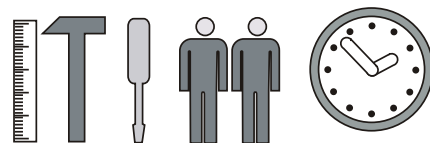





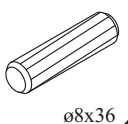

JASMIN 20G9_01

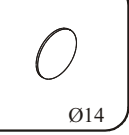
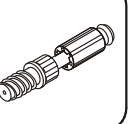

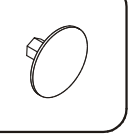
NO	Dim.		Col.-No	Qty
1	899	850	2	2
2	899	600	1	1
3	1492	80	4	2
4	746	80	4	2
5	746	160	4	2
6A	702	82	4	2
6B	702	82	4	2
7A	702	60	4	2
7B	702	60	4	2

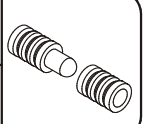
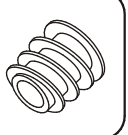

90 min

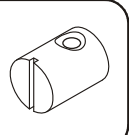
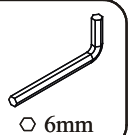
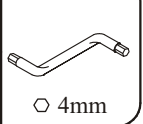
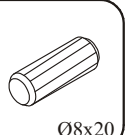
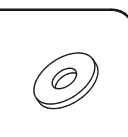
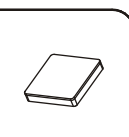
A1 x16  ø8x36	B14 x24  Ø7x30	G12 x24  Ø14	B4 x20 	B16 x12  ø15x16	G5 x20 
B5 x8  ø15x12	I2 x12 	D8 x48  øES5x13	H10 x1  L-1110mm.	KU x6 	B41 x20 
WG3 x16  M6x30	WS4 x12  M6x90	N1 x8 	G21 x1  Ø 6mm	G2 x1  Ø 4mm	A2 x2  Ø8x20
P4 x4 	P5 x4 				

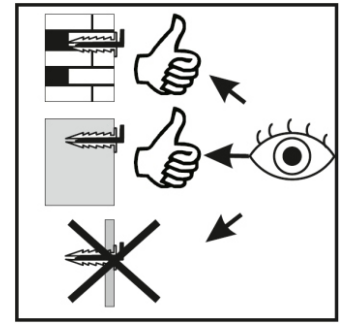
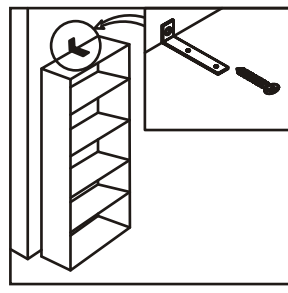
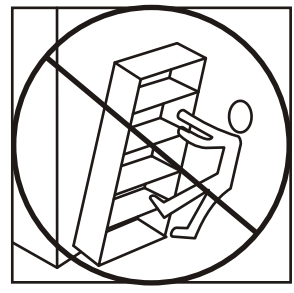
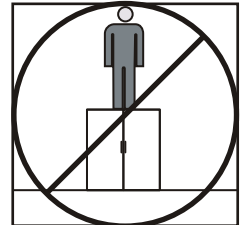
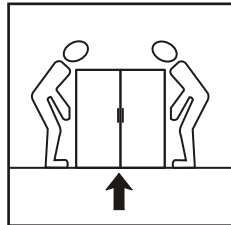
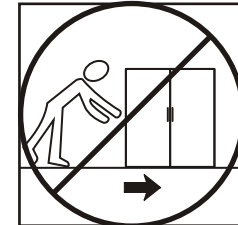
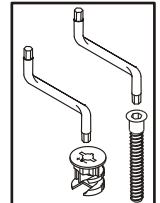
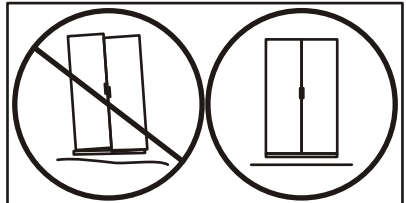
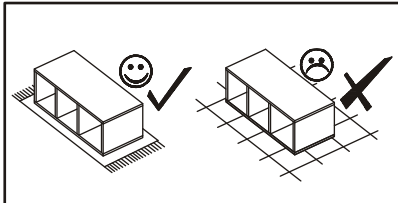
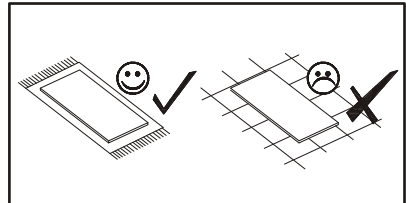
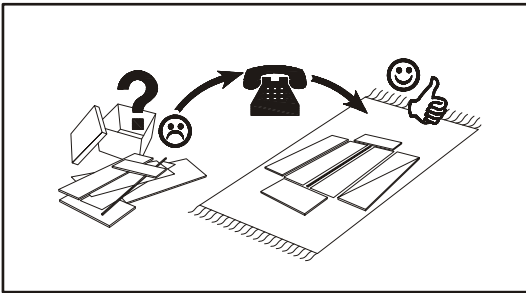
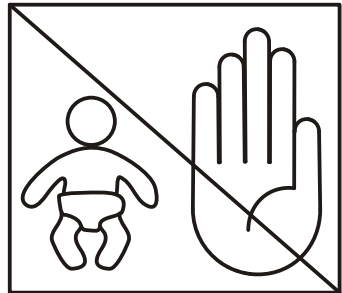
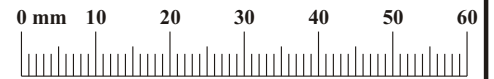

1

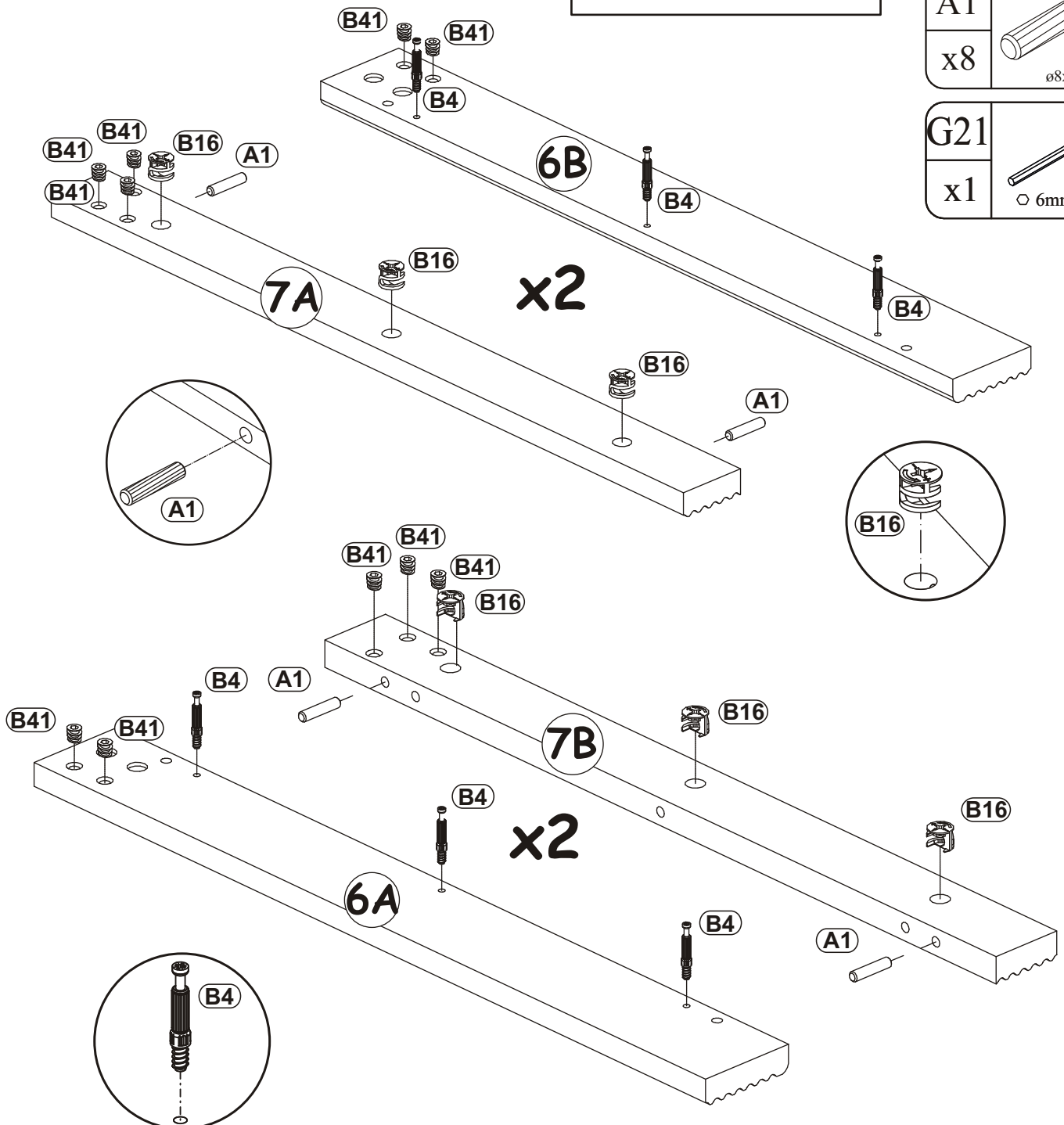
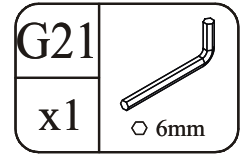
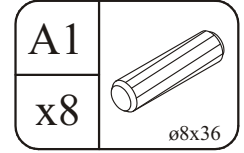
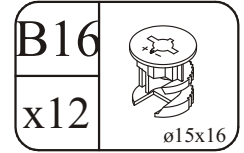
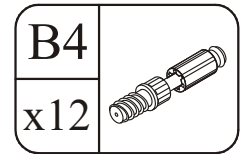
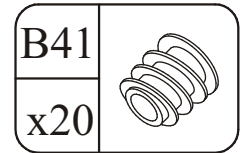
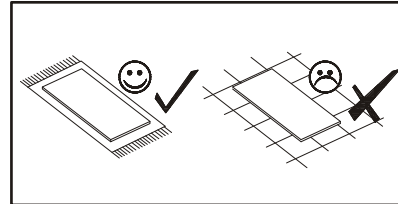
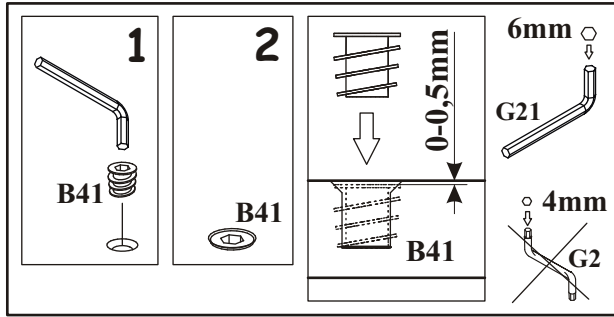
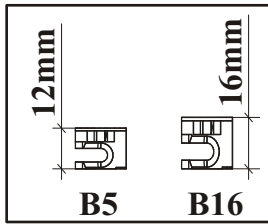

2

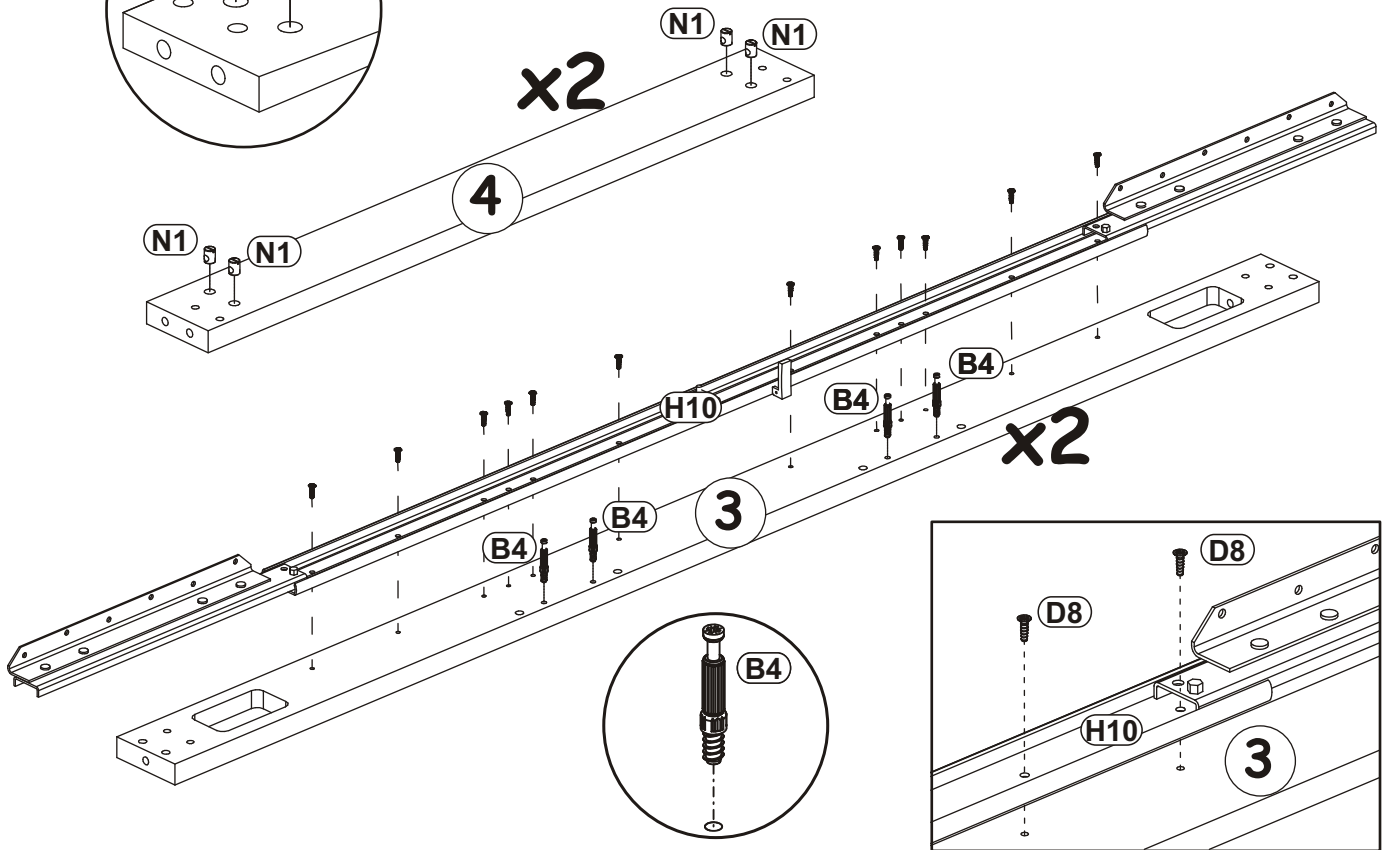
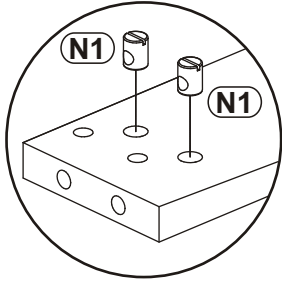
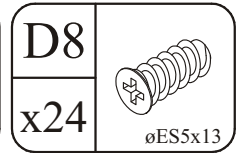
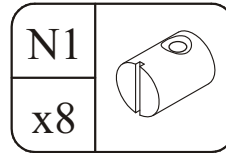
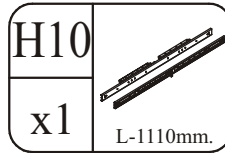
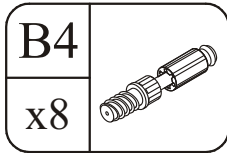

3

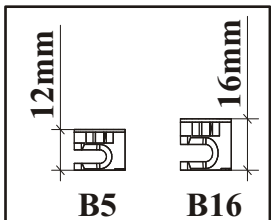
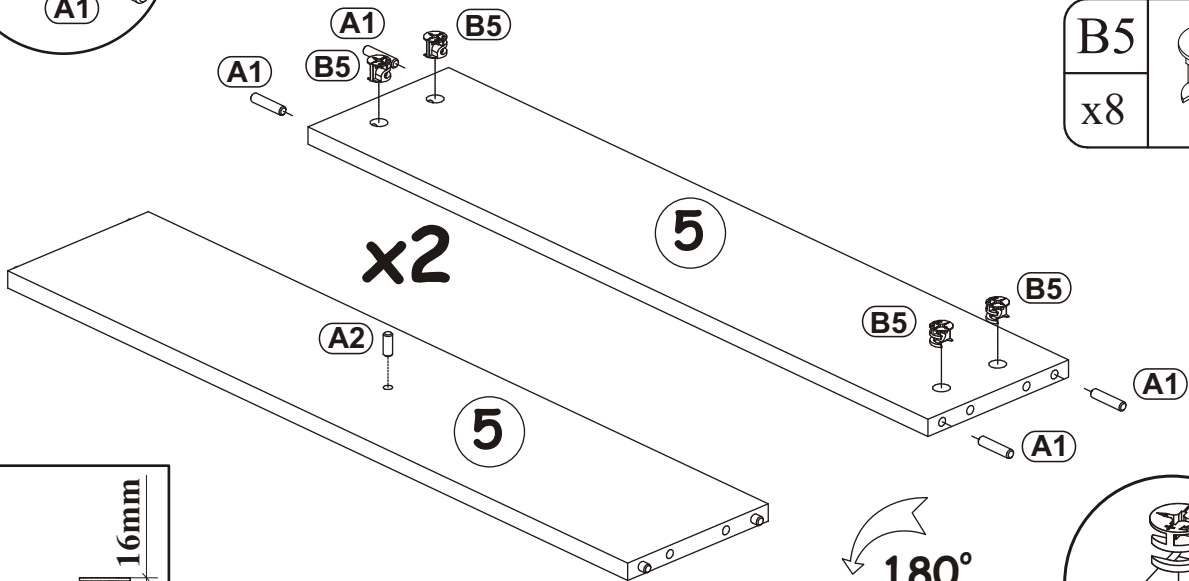
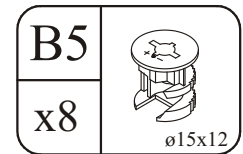
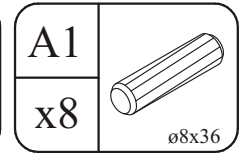
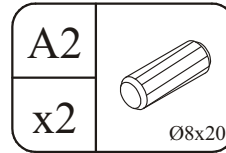
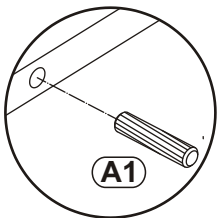

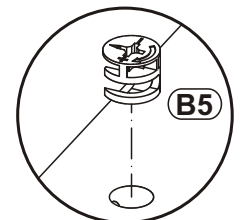

180°

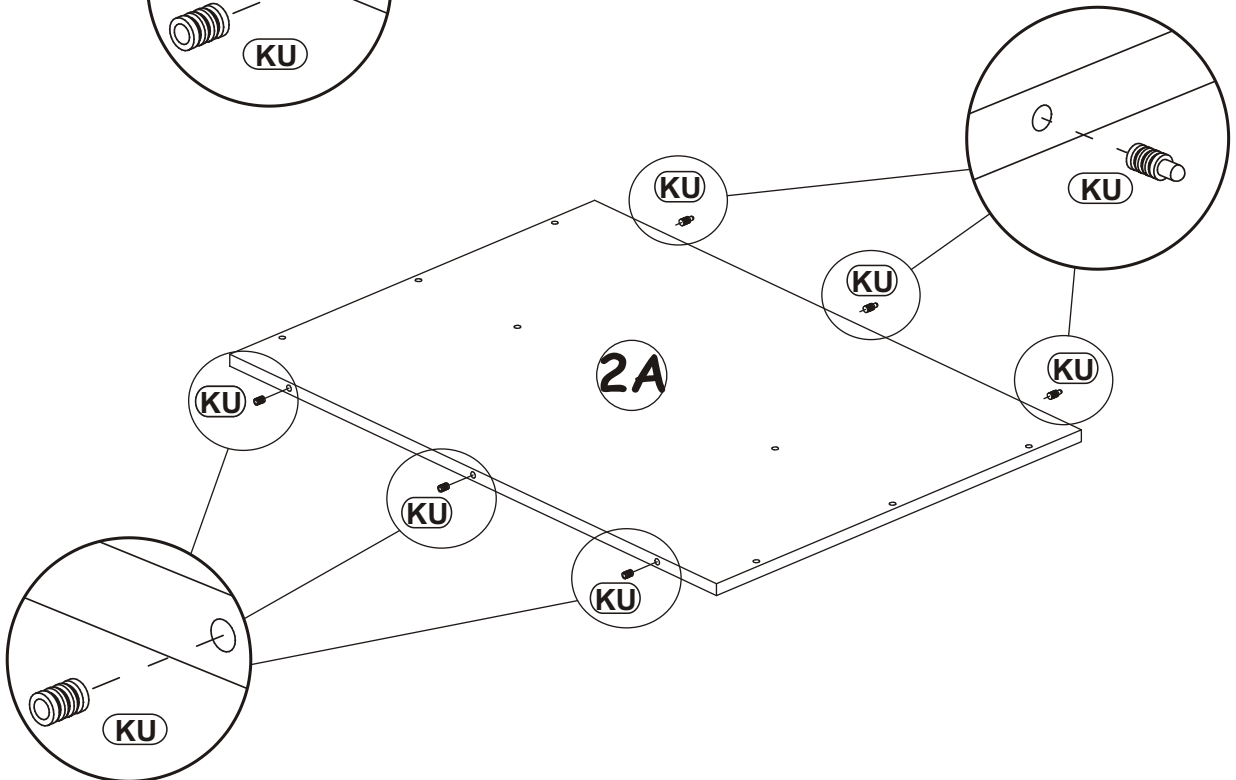
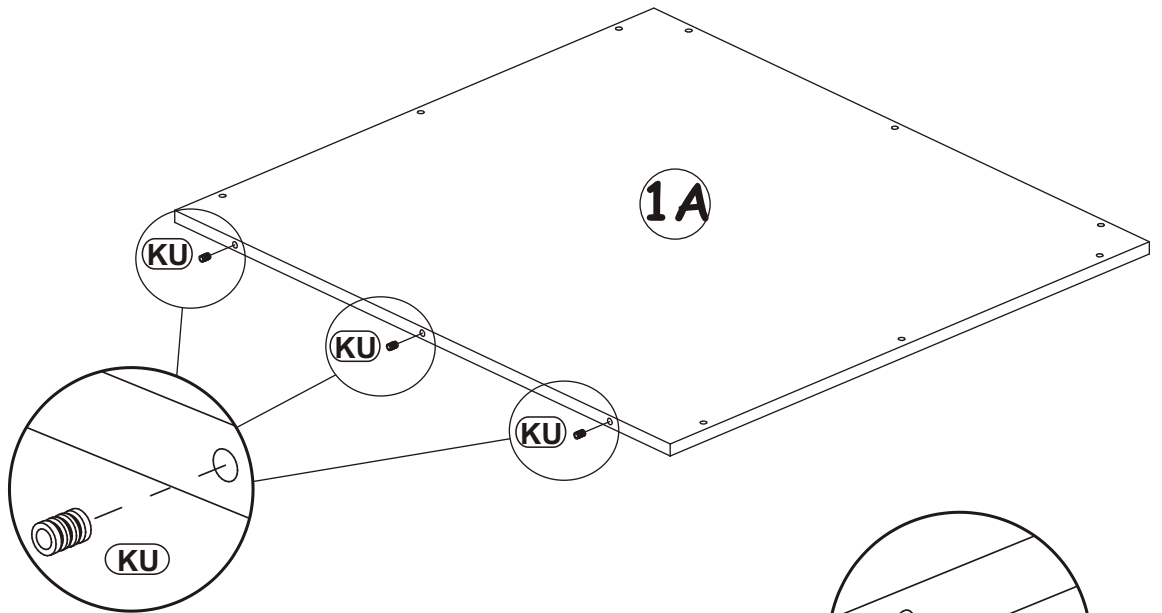
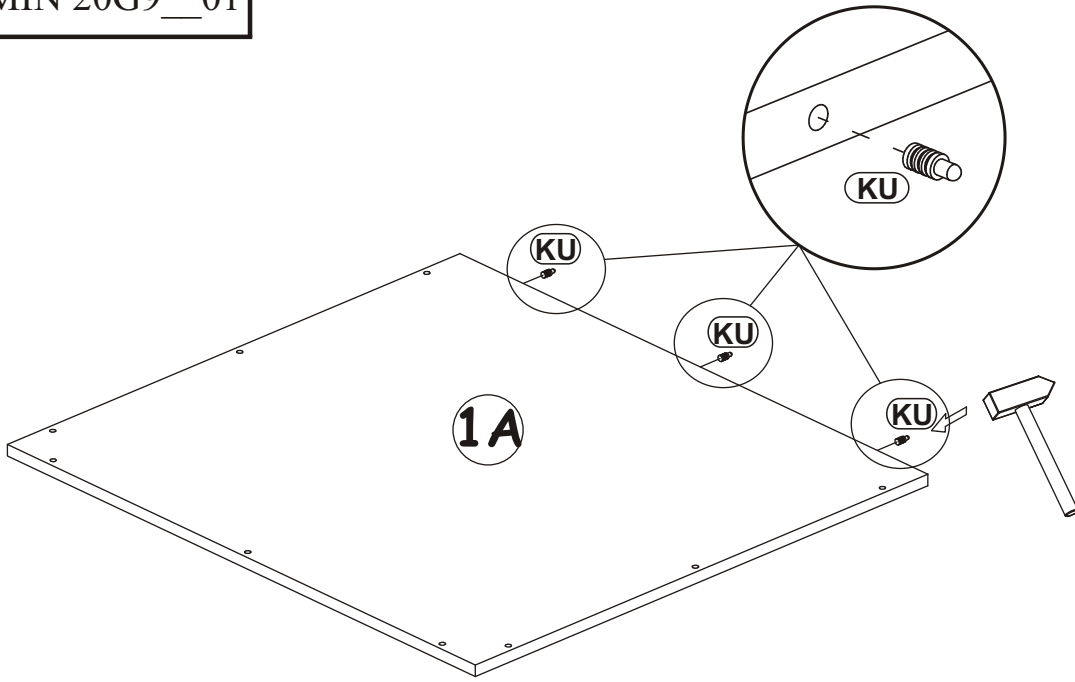
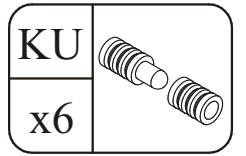

4



5

B14		G12	
x24	Ø7x30	x24	Ø14

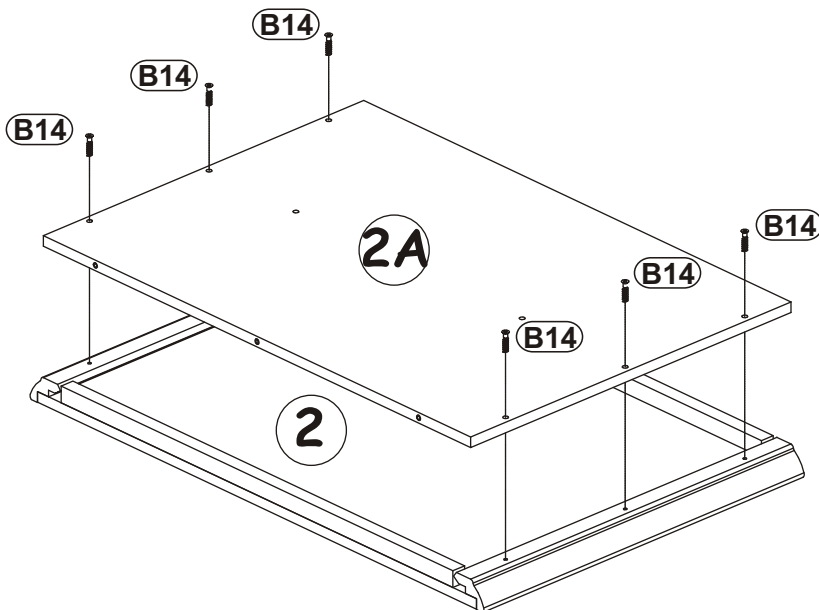
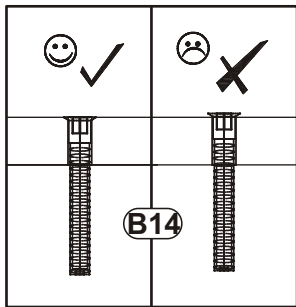
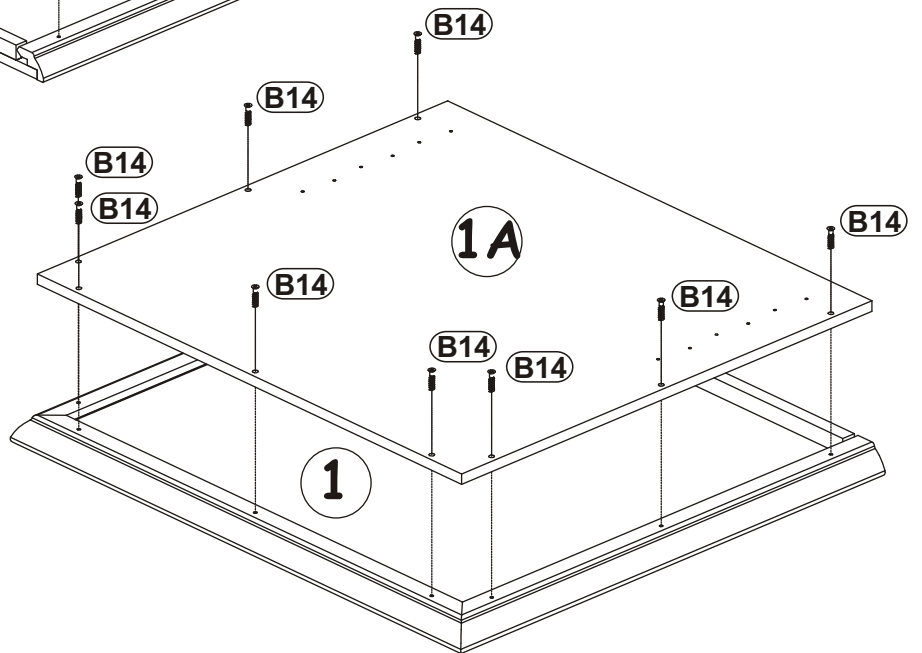
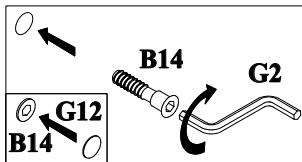
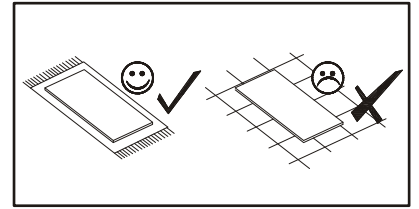
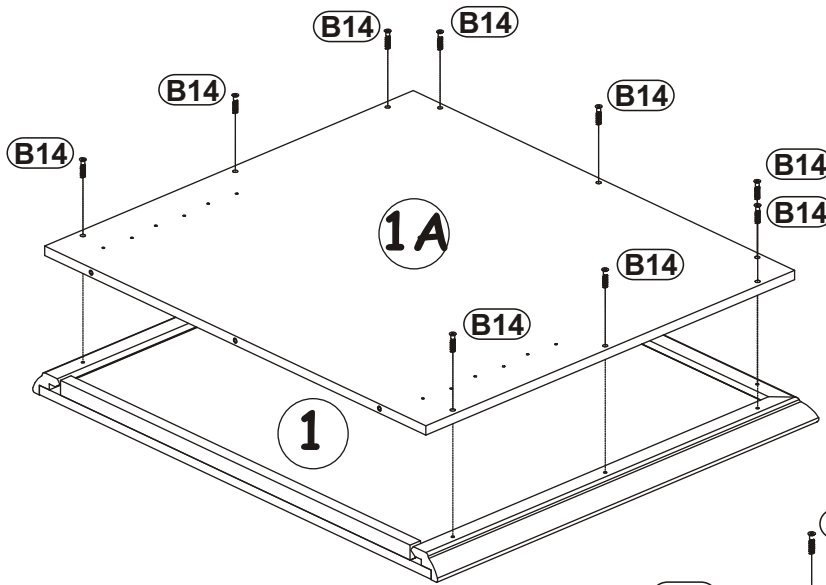

6

G5	
x12	

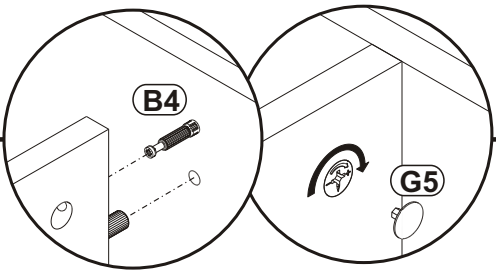
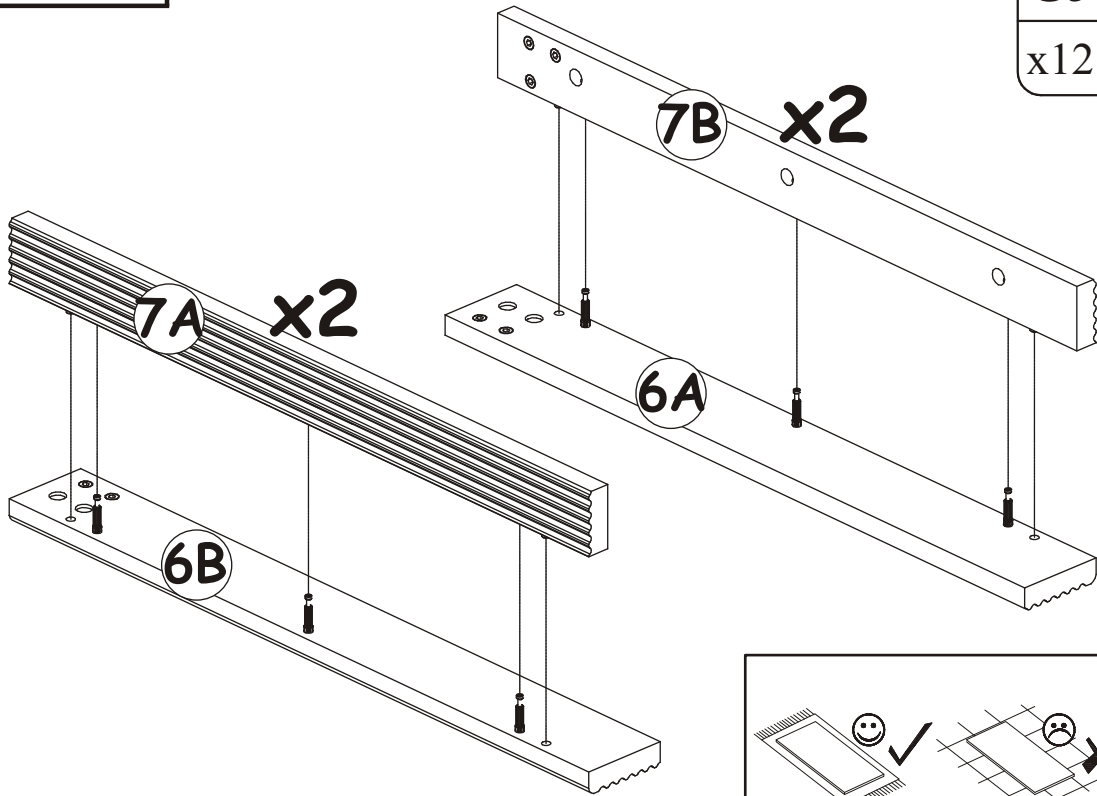

7

WS4		G5	
x8		M6x90	

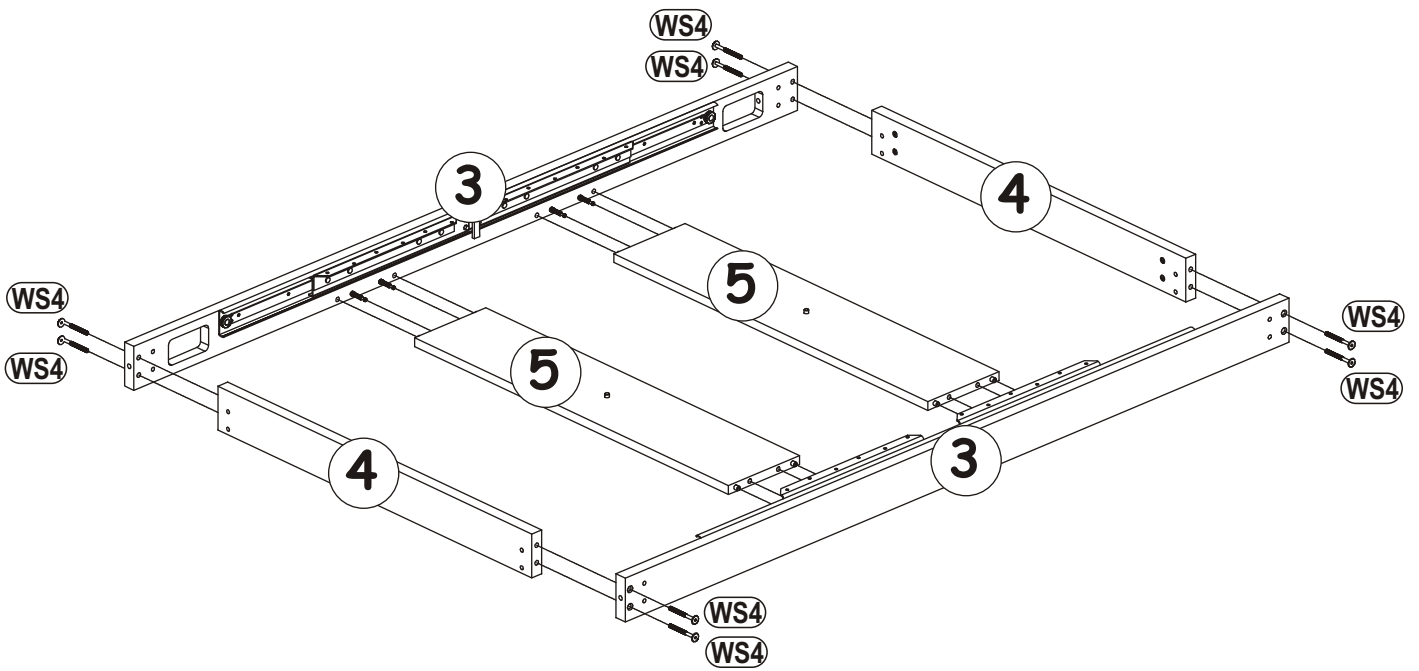

8

D8	
x24	

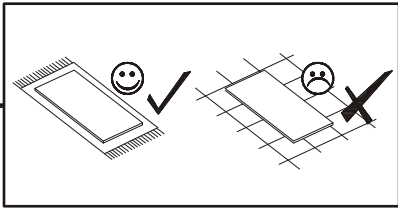
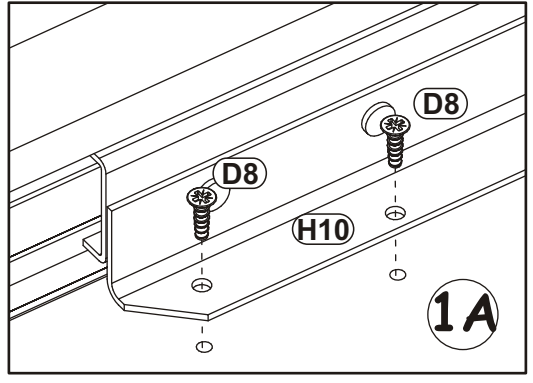
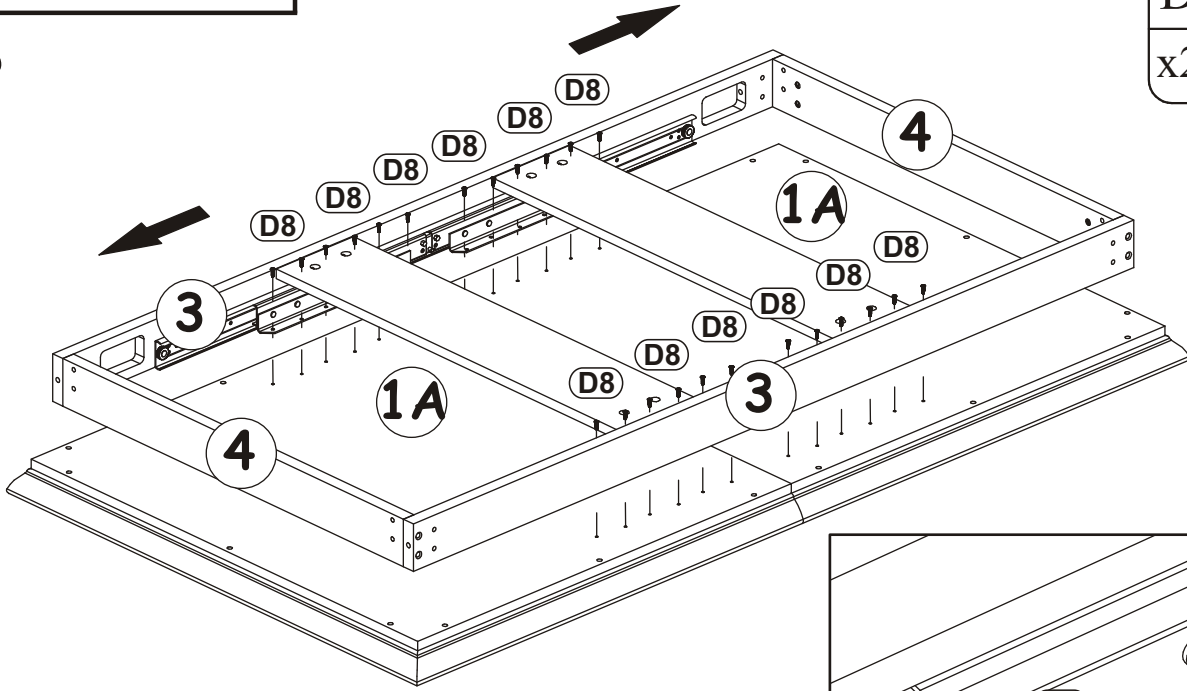

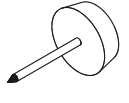

9

WG3	
x16	

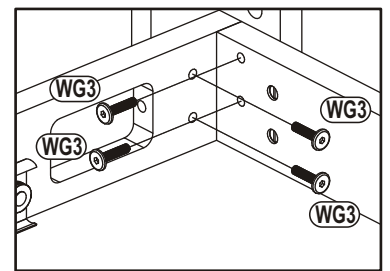
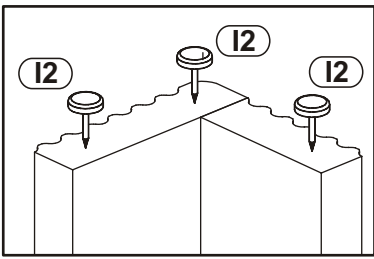
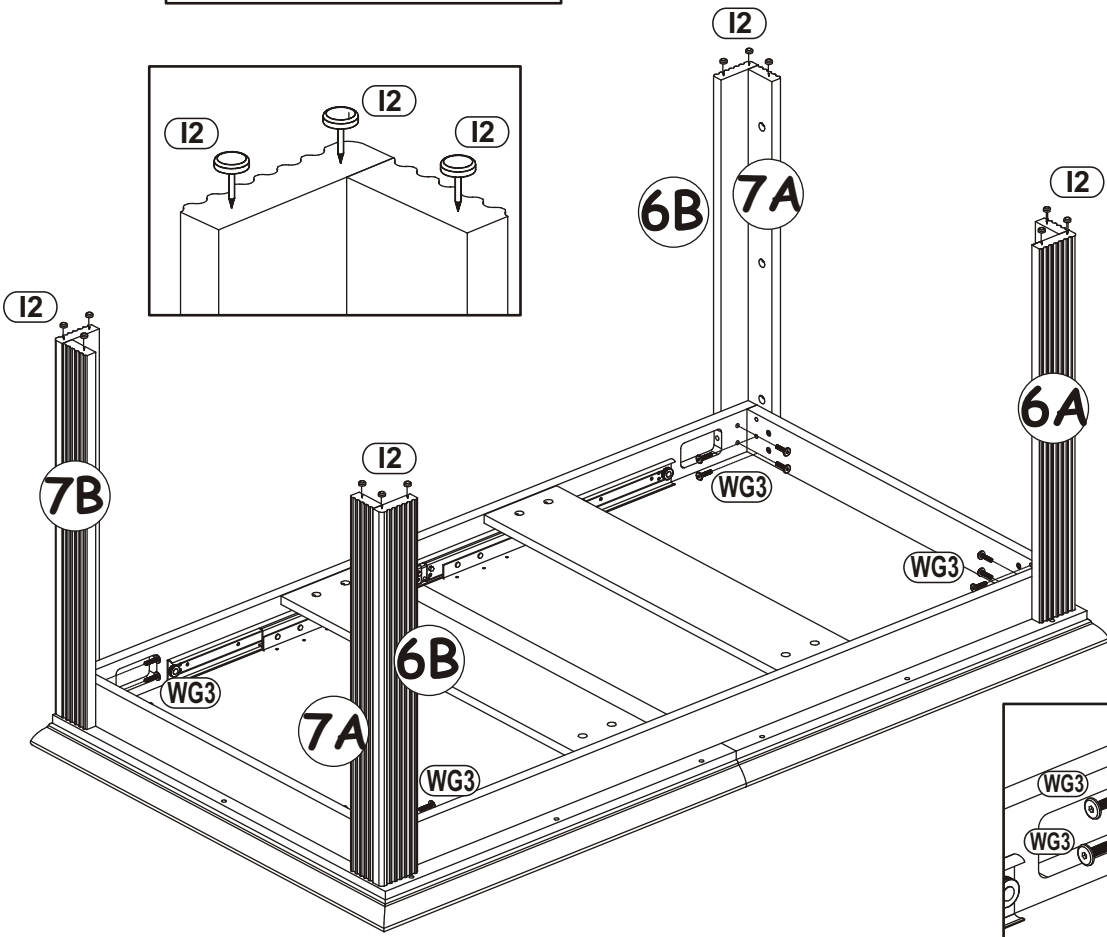
I2	
x12	



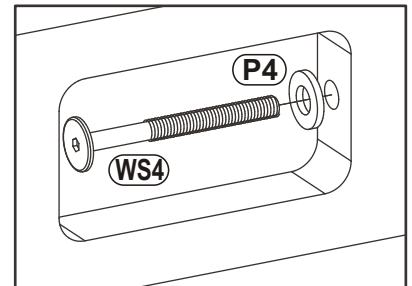
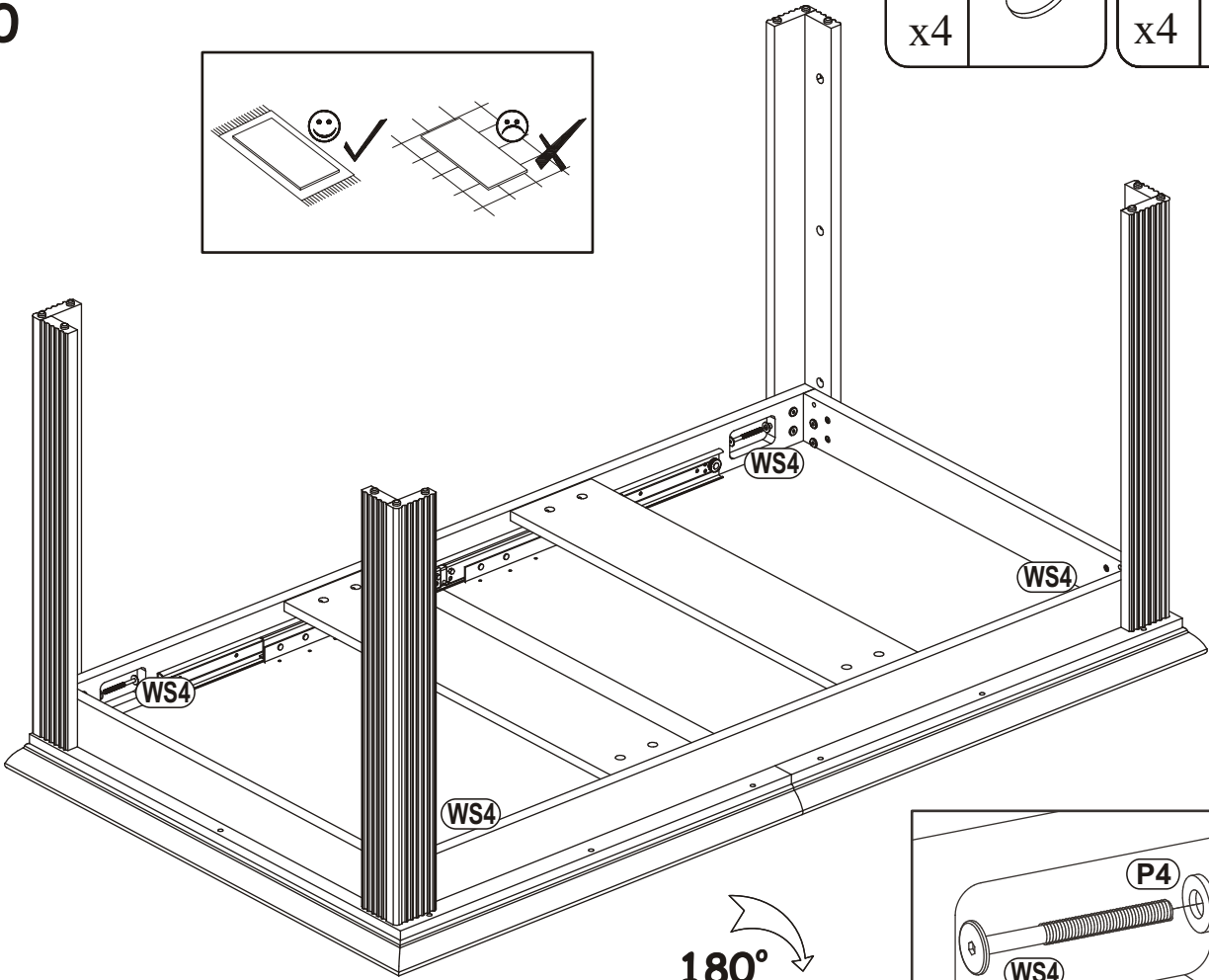
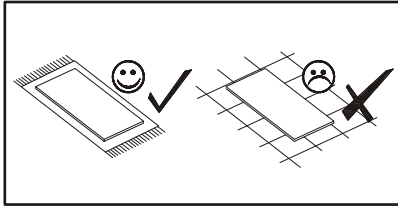

10

P4		WS4	
x4		x4	M6x90

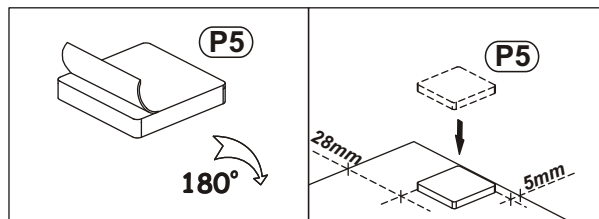

11



P5	
x4	

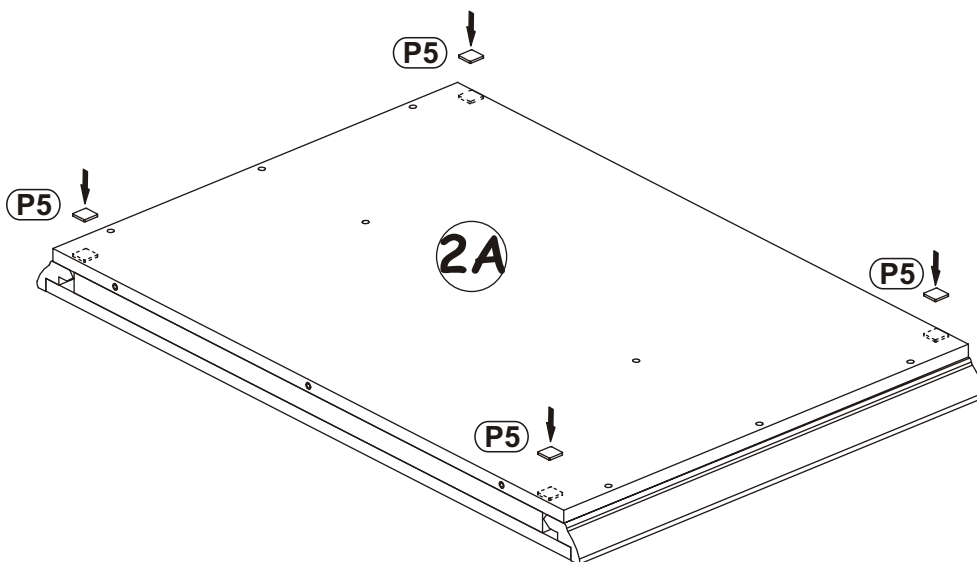

12

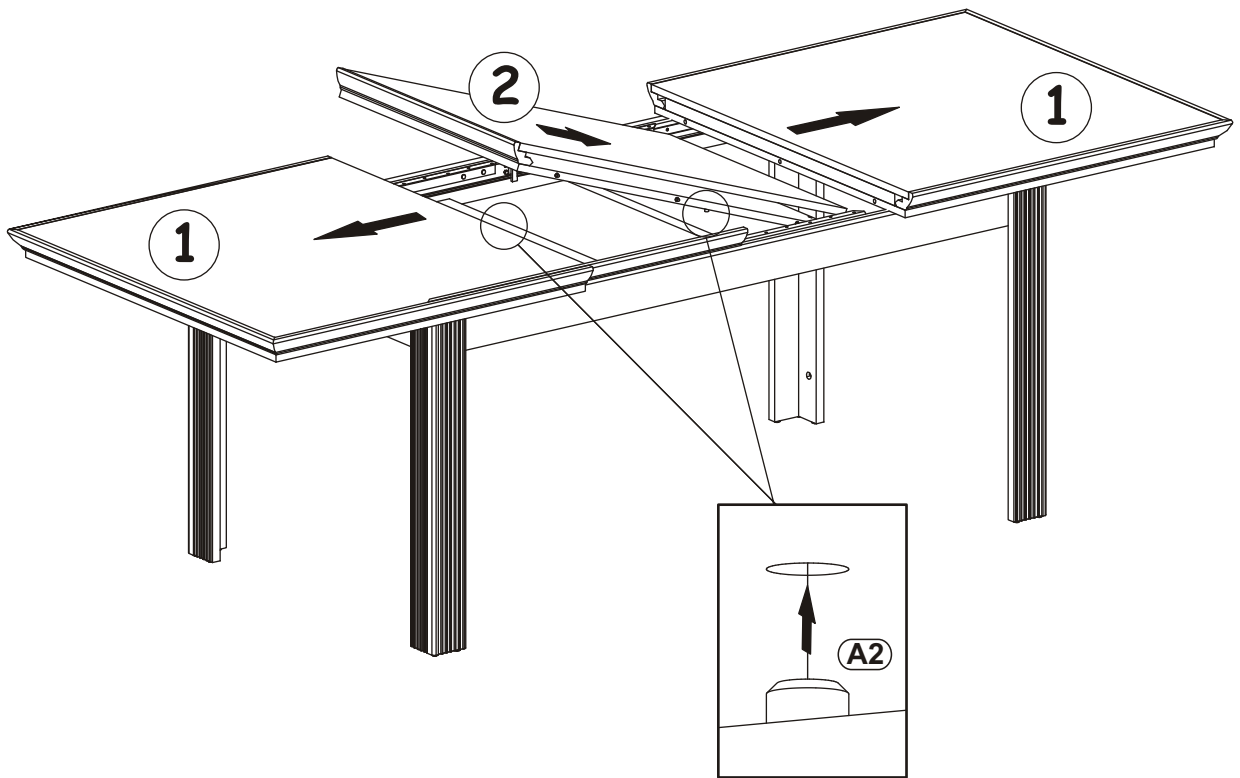

13

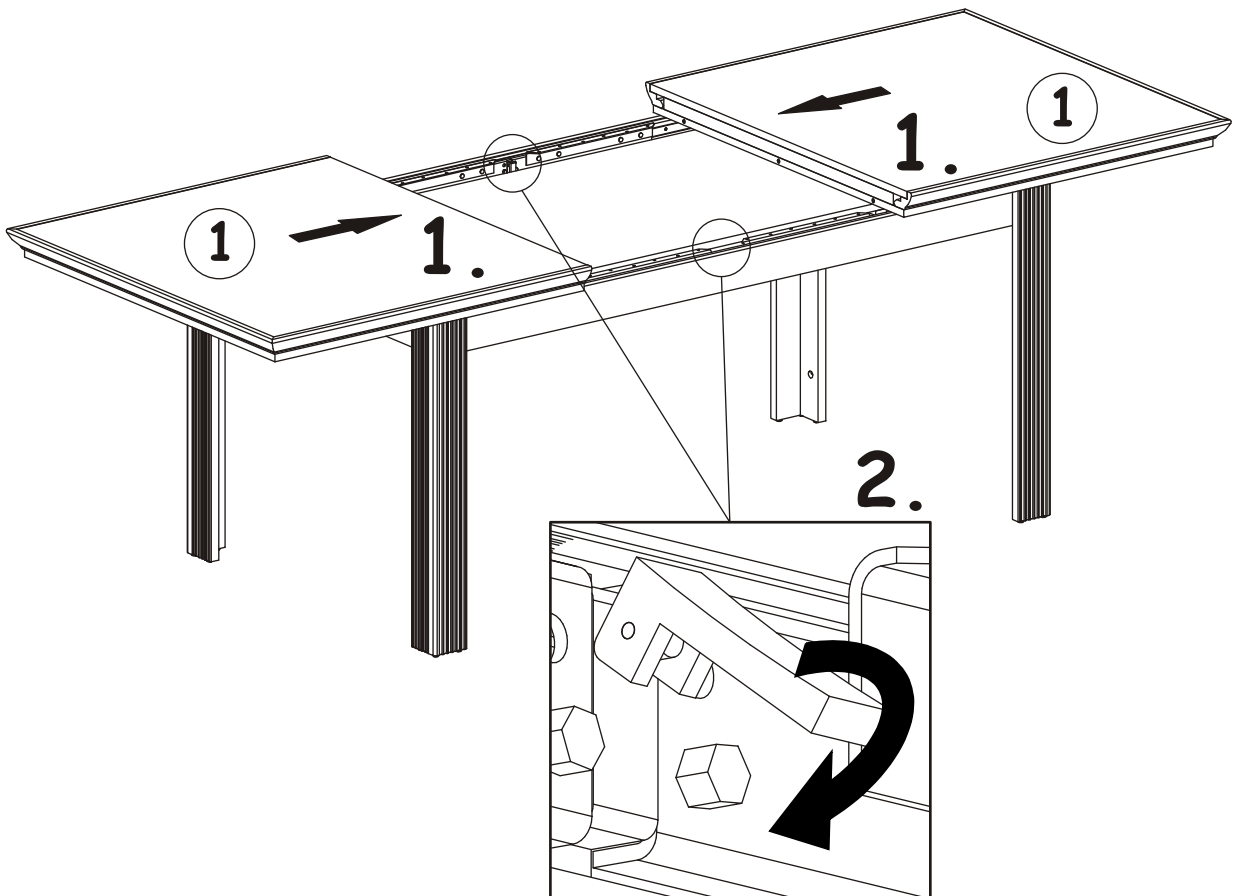

14

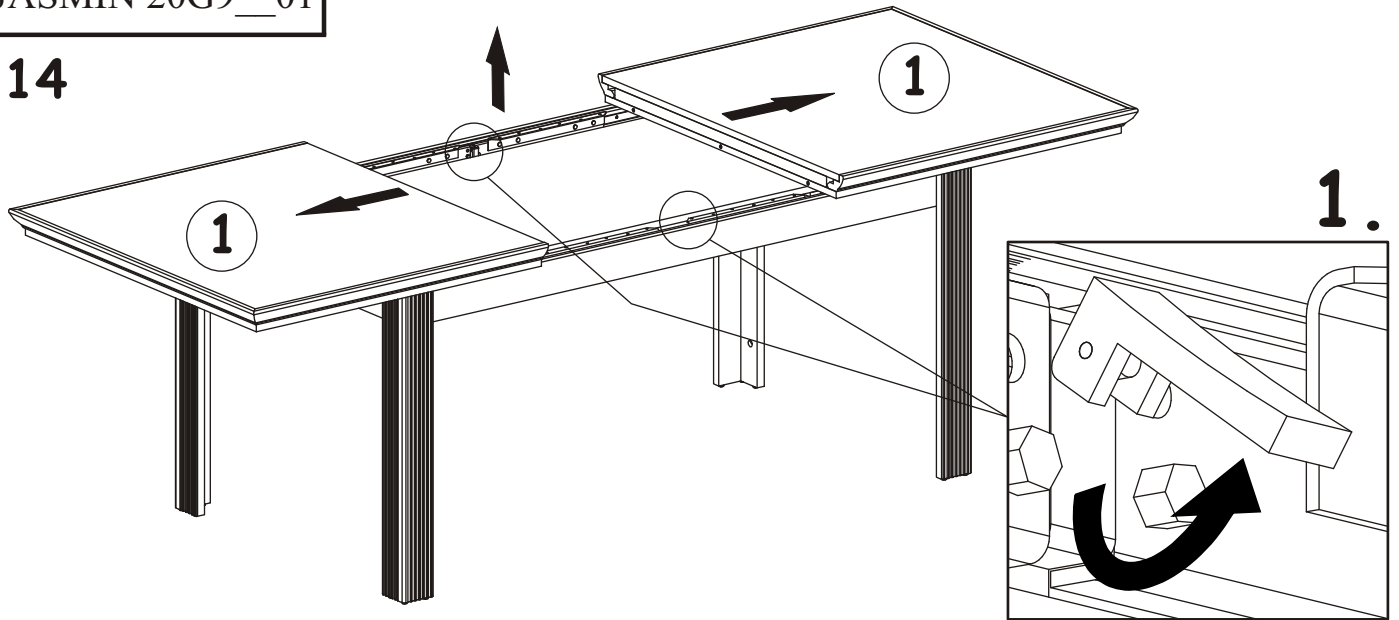

15

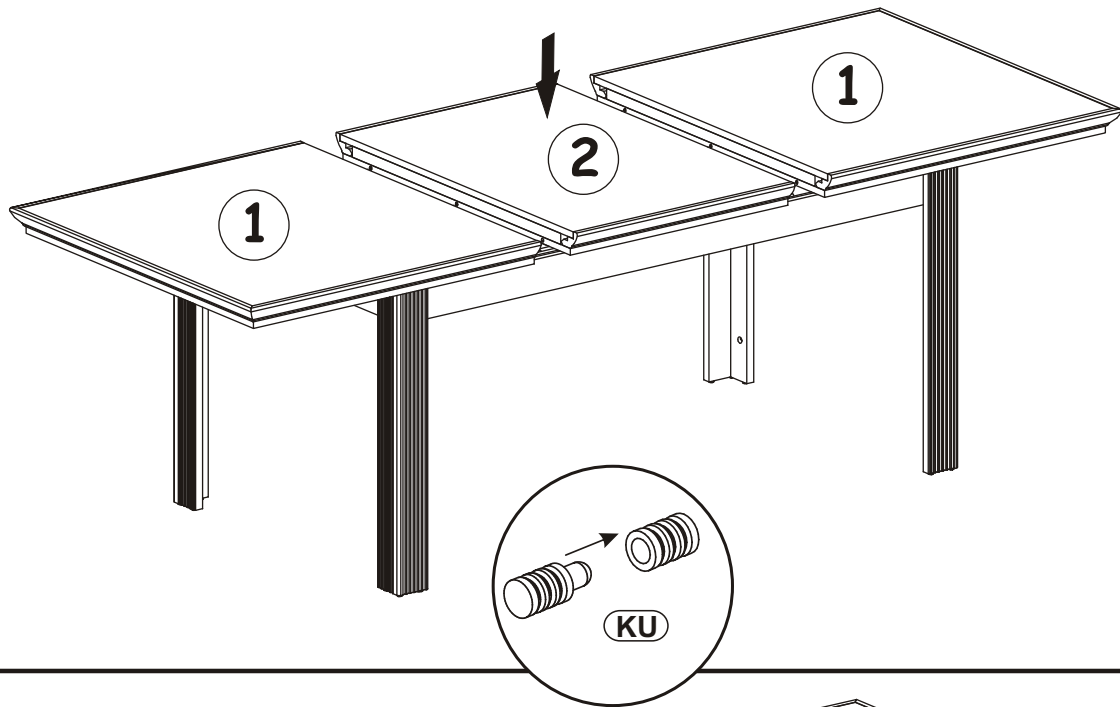

16

