

**A****M222-LUS/7/13****3096--51**

2 / 5

**30min**

A	B	C (mm)		D
1	M222-3003	1317	150	1/1
2	M222-4503	668,	1156	1/1
3	M222-5001	668,	80	1/1

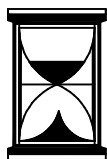
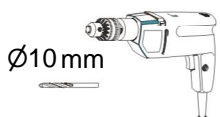
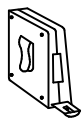
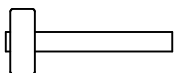
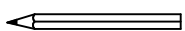
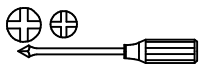
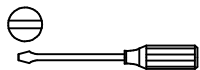
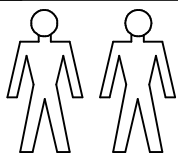
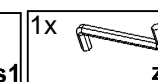
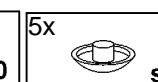
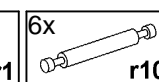
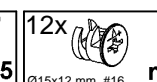
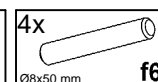
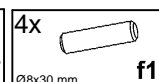
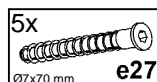
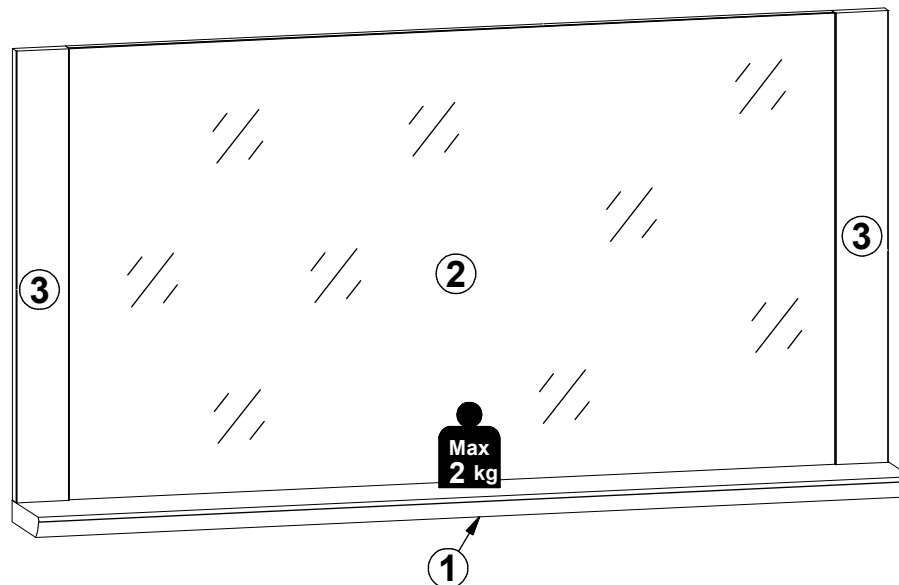

1

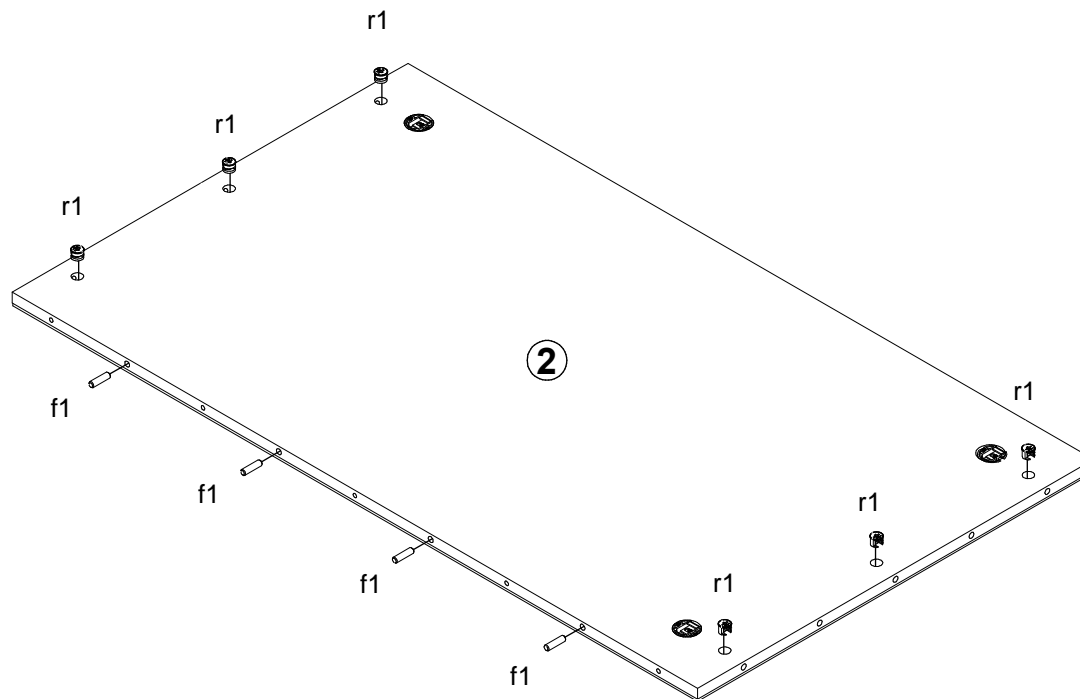
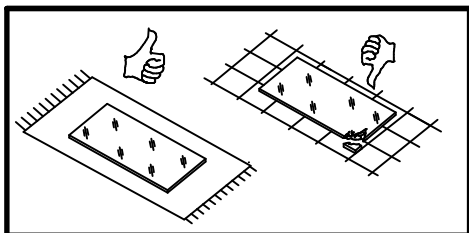
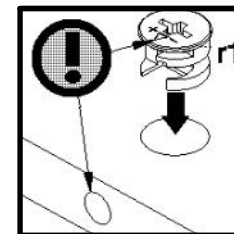

2x

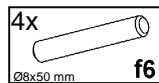
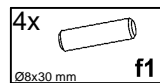
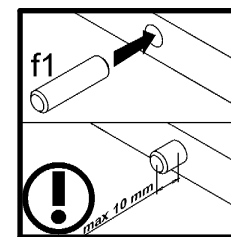
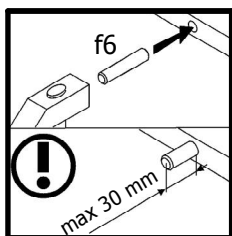
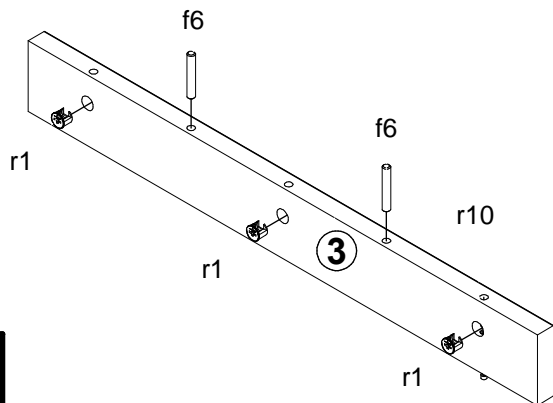

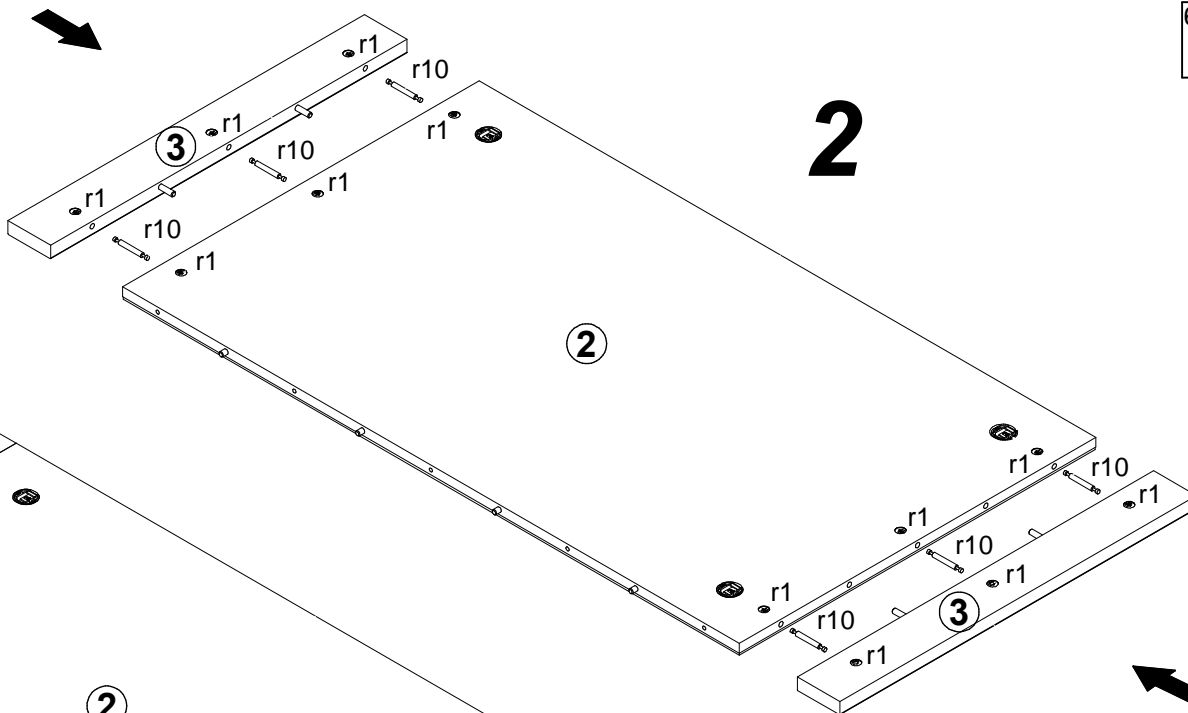
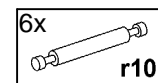

3

2

2

3

2

1

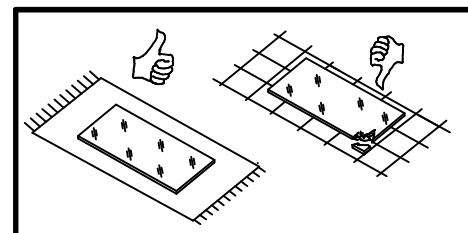
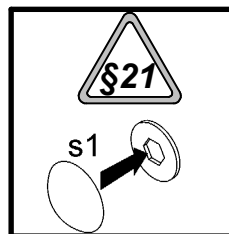
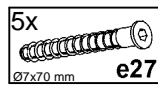
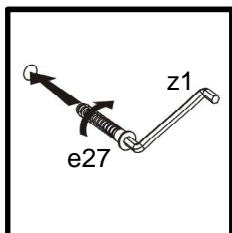
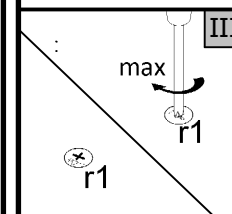
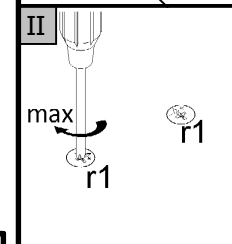
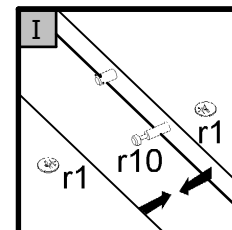
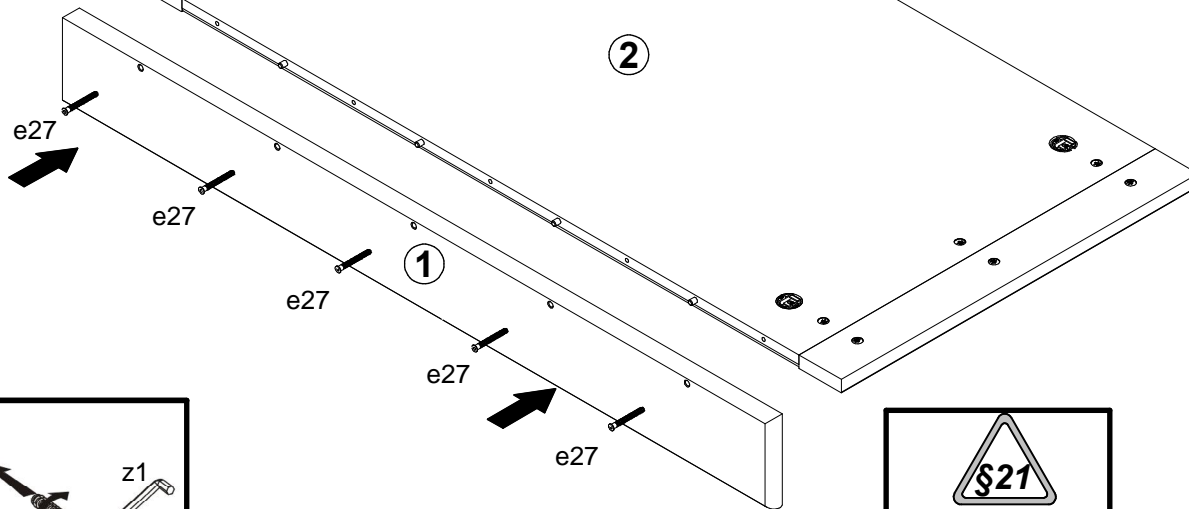

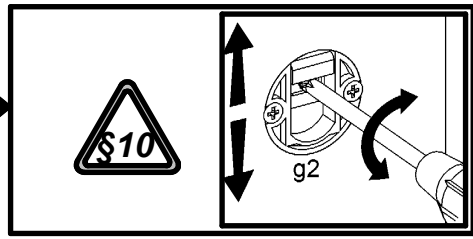
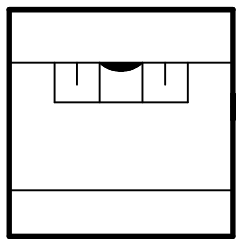

5

