

A	B	C1	C2	C3	D
1	S507-1001	1944	340	16	2/2
2	S507-1002	1944	340	16	2/2
3	S507-2001	600	363	22	1/2
4	S507-2002	600	340	16	1/2
5	S507-3001	567	320	16	2/2
6	S507-3002	566	310	16	2/2
7	S507-3003	560	300	6,	1/2
8	S507-3004	567	320	16	2/2
9	S507-7001	738	596	19	1/2
10	S507-7002	738	596	19	1/2
11	S507-7801	492,	596,	20,5	1/2
12	S507-9001	717	577	2,5	1/2
13	S507-9002	518	577	2,5	1/2

4x 	2x 	4x 	1x
8x 	4x 	16x 	4x
2x 	4x 	12x 	8x
12x 	8x 	8x 	2x
8x 	12x 	12x 	4x
			1x
1x 	1x 	1x 	1x
1x 	1x 	1x 	2x



- 4x d1 $\varnothing 5 \times 17 \text{ mm}$
- 2x r1 $\varnothing 15 \times 12 \text{ mm} \#16$
- 4x f1 $\varnothing 8 \times 30 \text{ mm}$
- 4x r42 $20/11$
- 2x d38



1

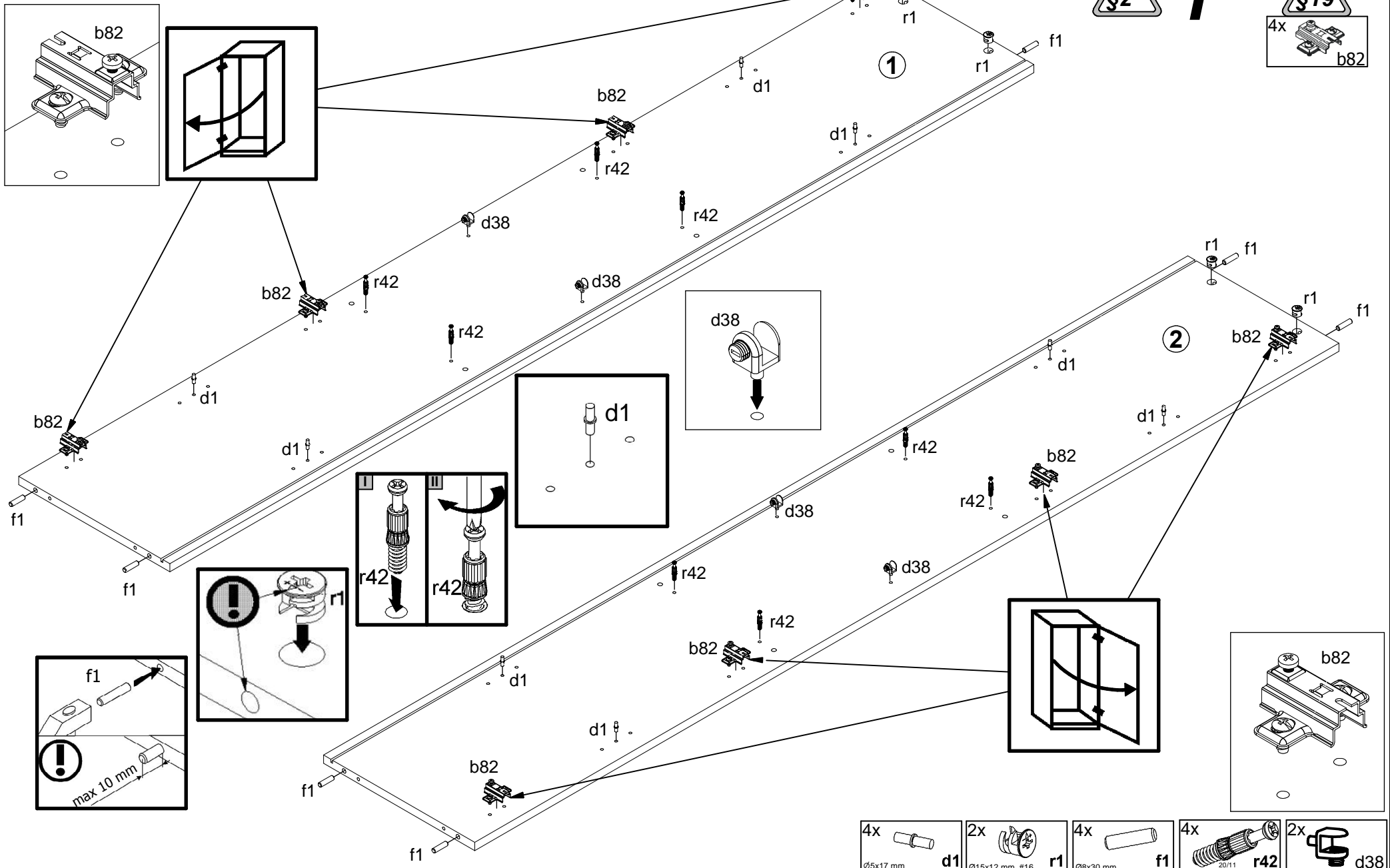
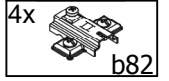



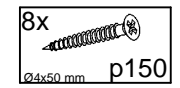
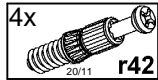
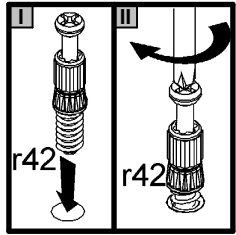

- 4x d1 $\varnothing 5 \times 17 \text{ mm}$
- 2x r1 $\varnothing 15 \times 12 \text{ mm} \#16$
- 4x f1 $\varnothing 8 \times 30 \text{ mm}$
- 4x r42 $20/11$
- 2x d38

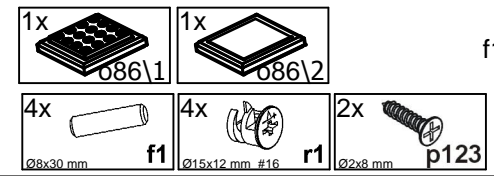
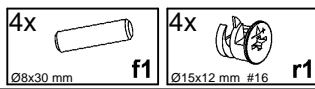
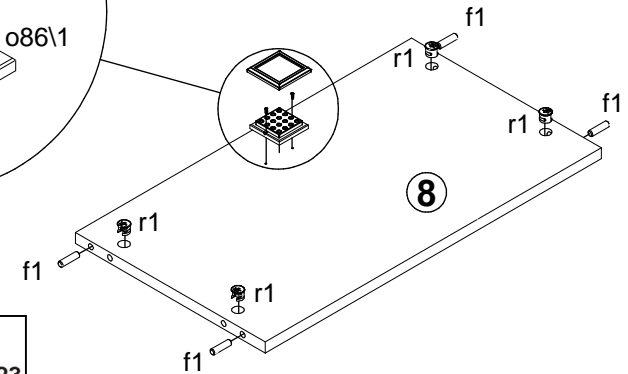
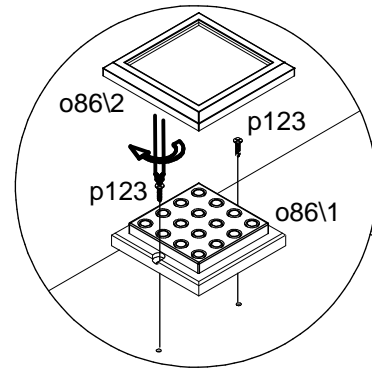
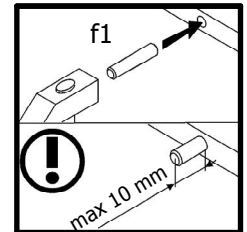
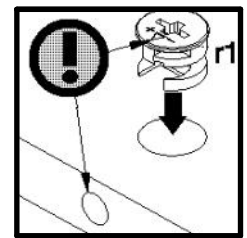
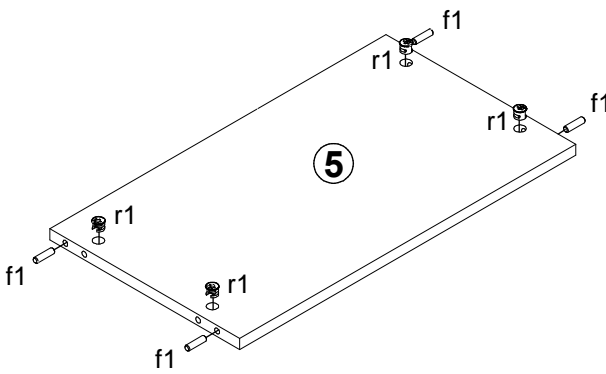
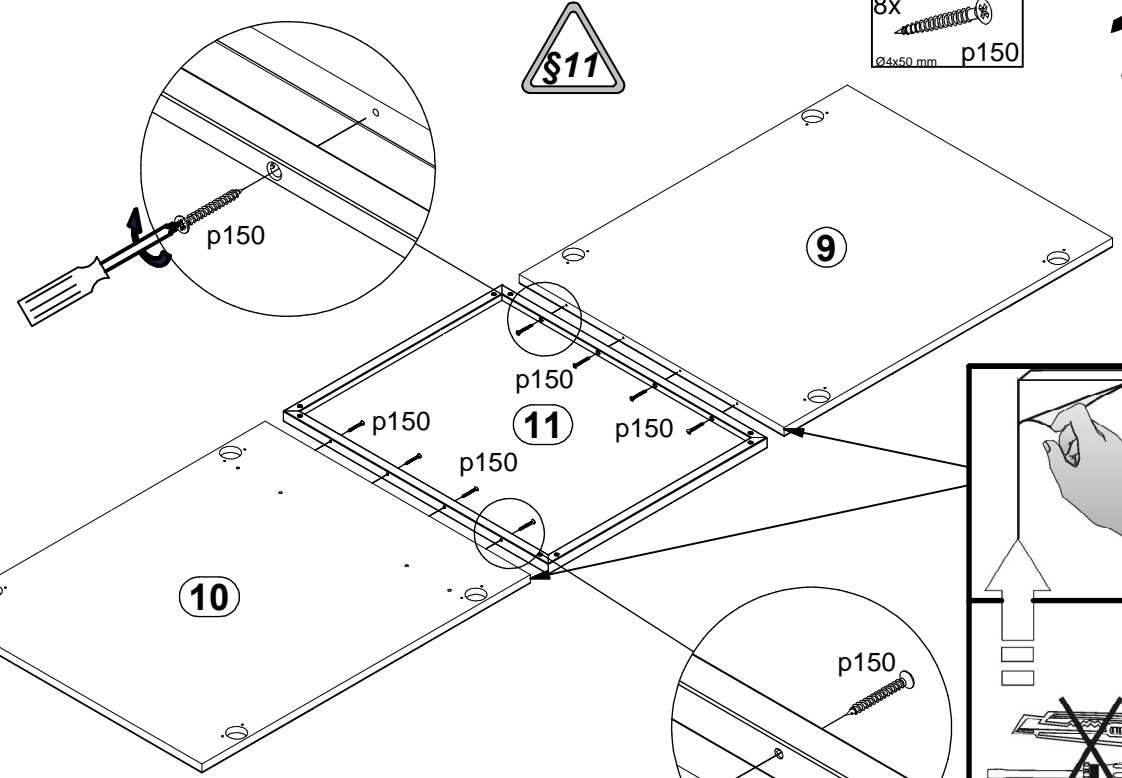
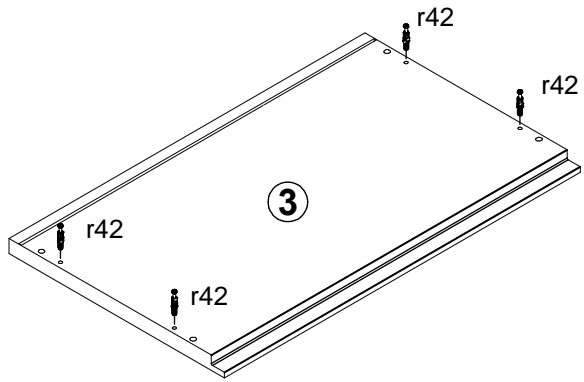

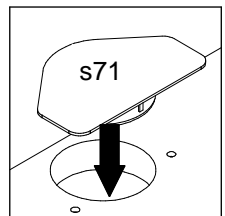
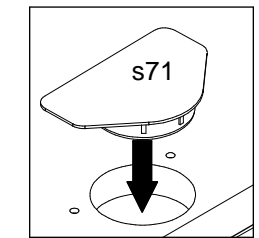
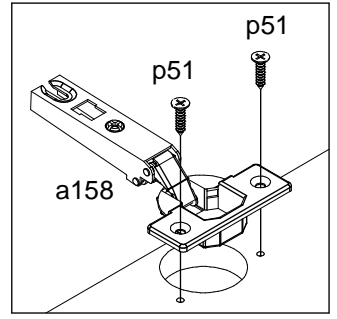
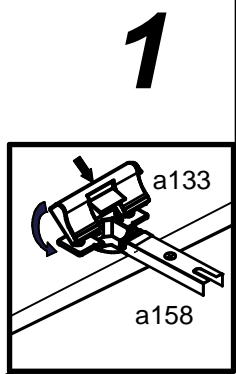
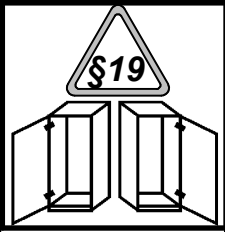
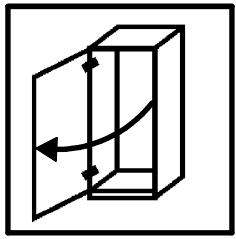
1





- 4x  a158
- 2x  a133
- 8x  p51
- 4x  s71

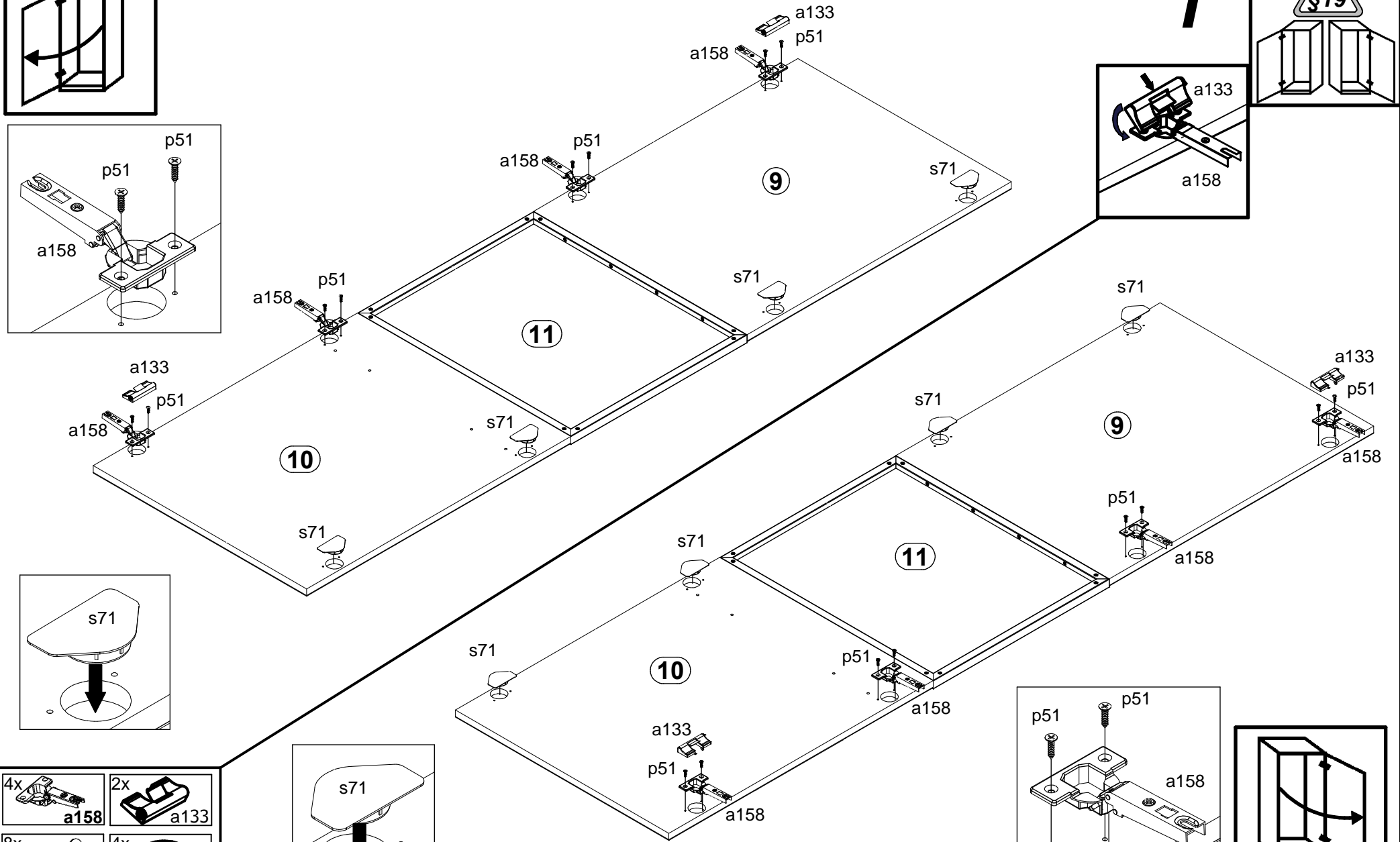
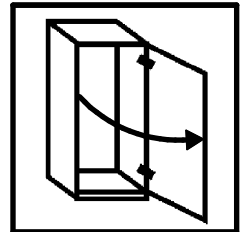
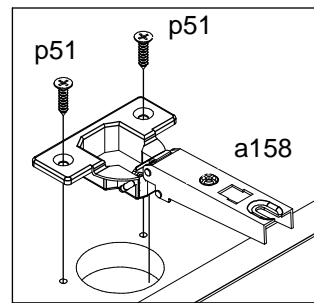

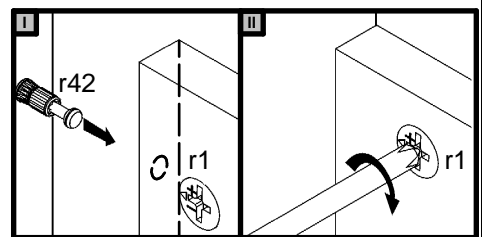
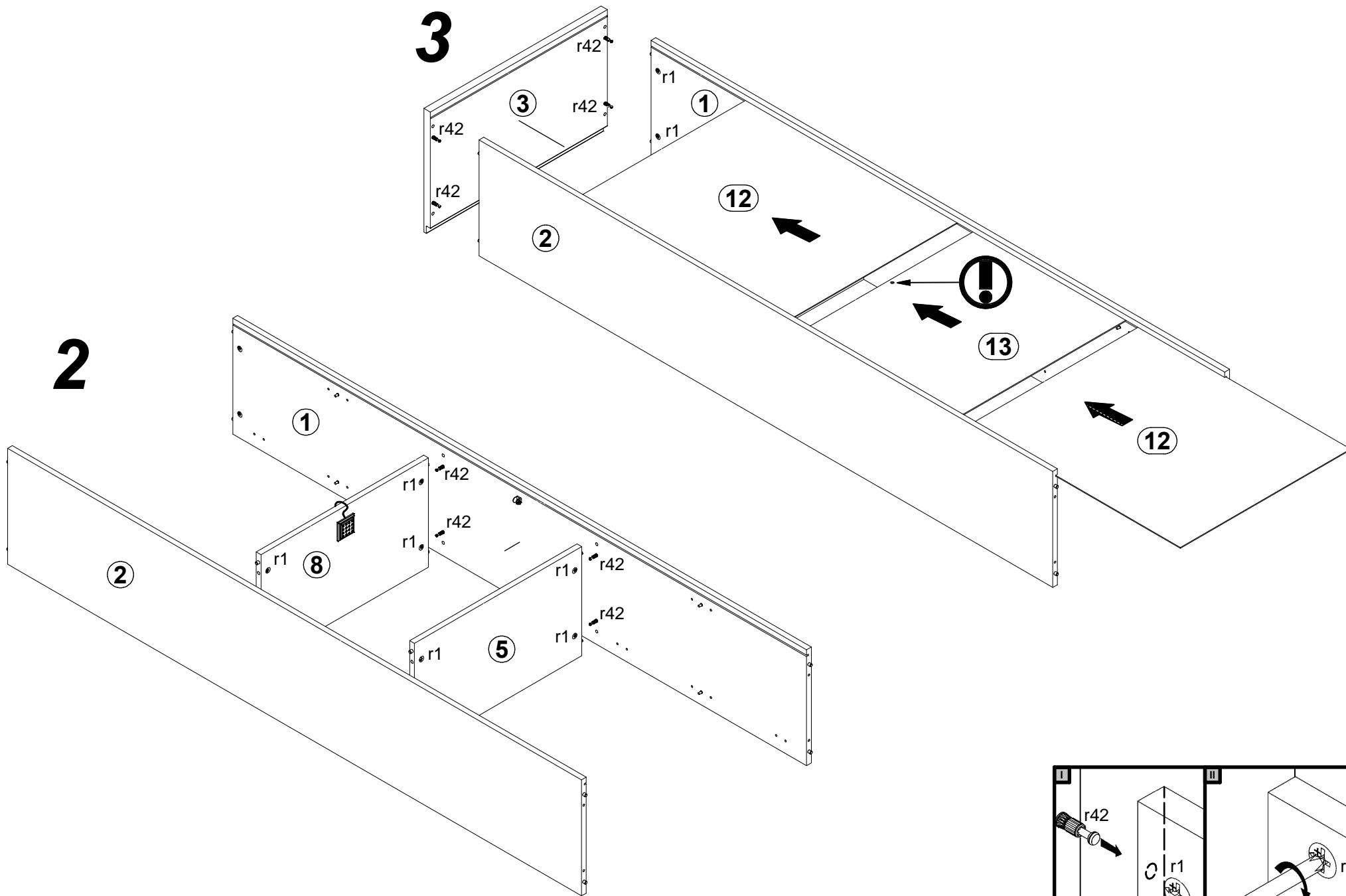

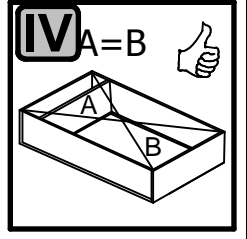
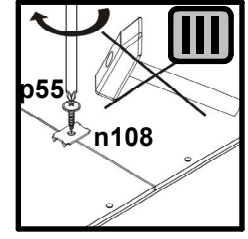
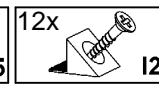
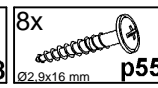
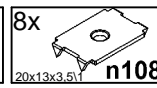
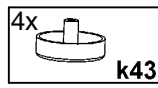
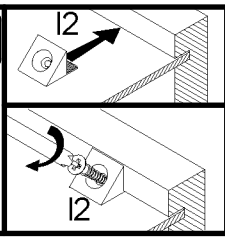
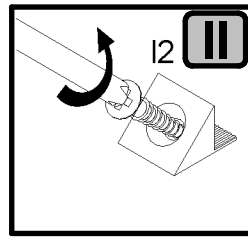
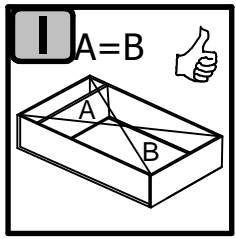

5

4

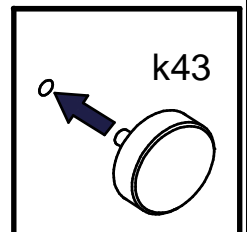
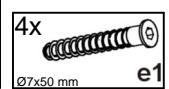
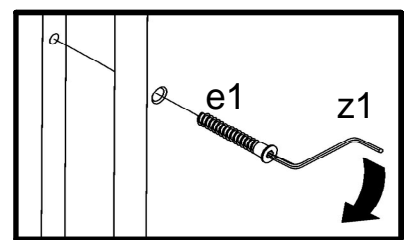
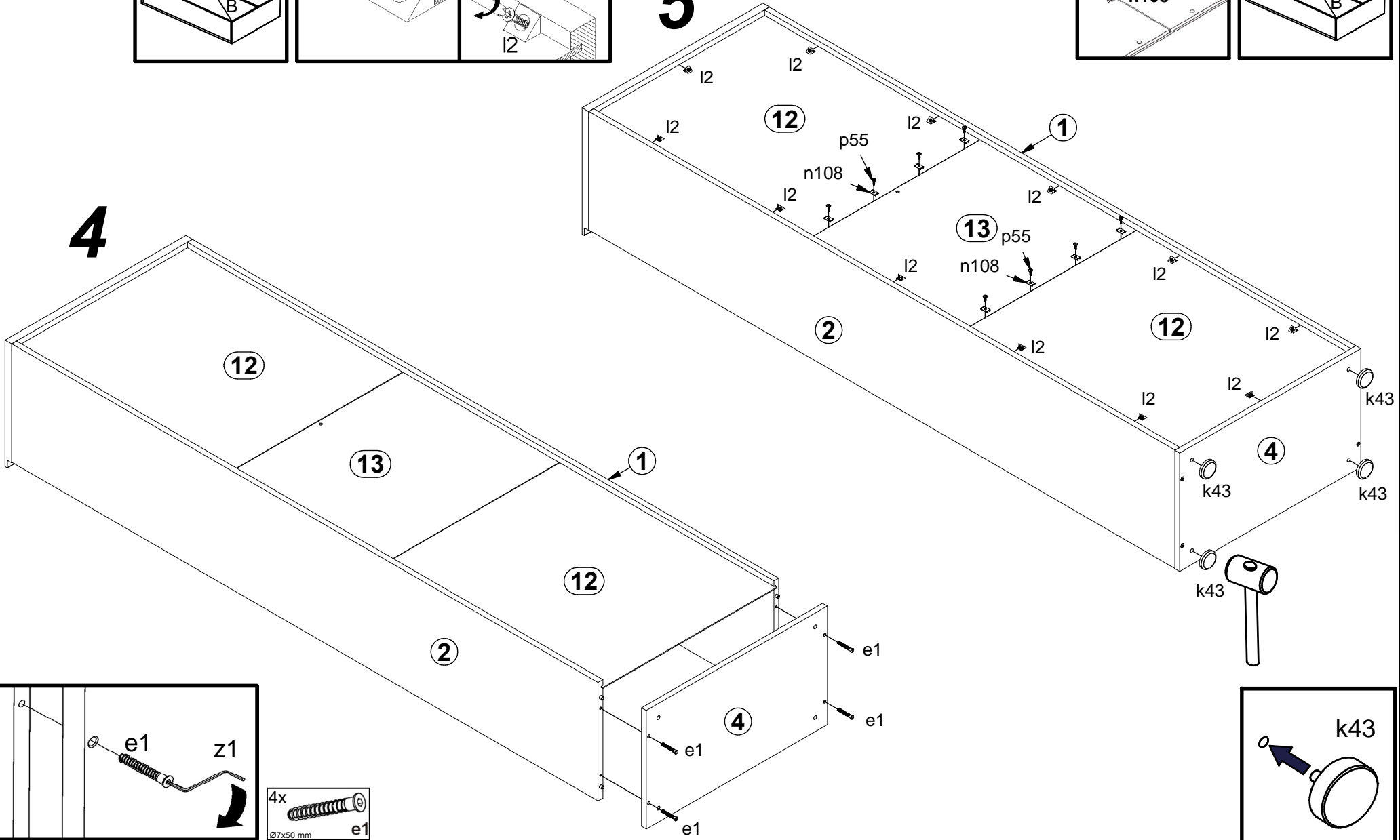

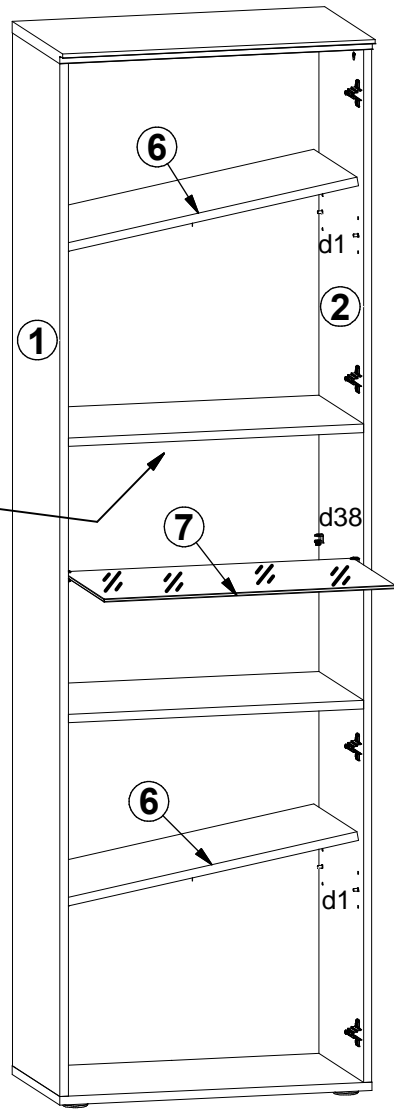
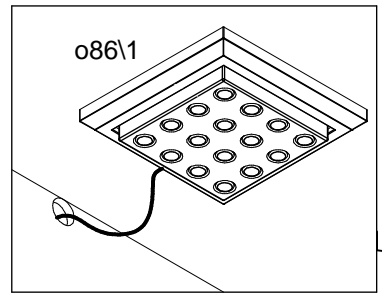
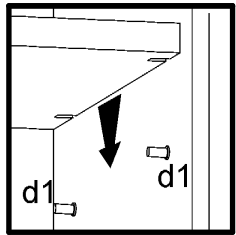
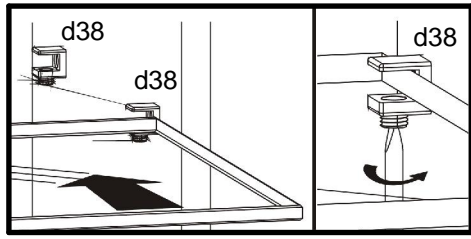

6

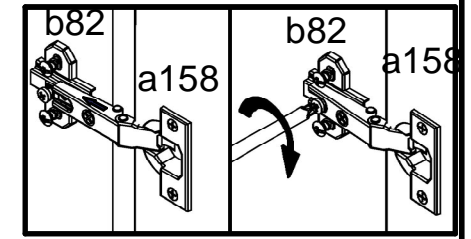
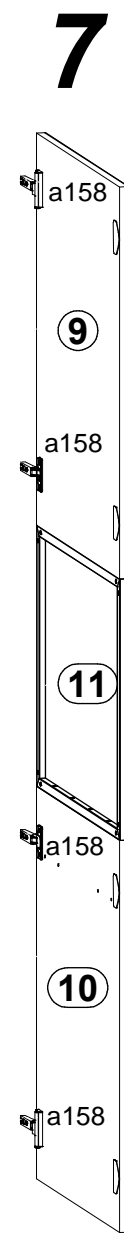
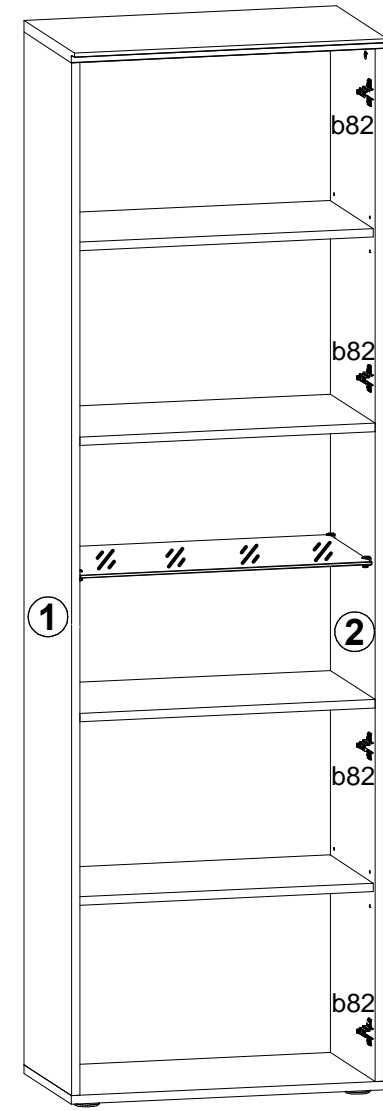

7

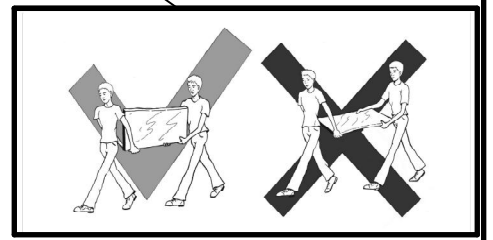
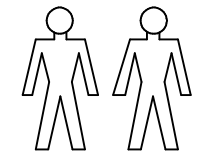

8

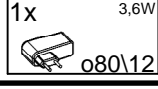
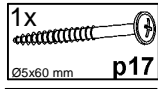
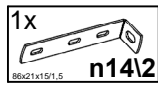
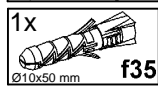
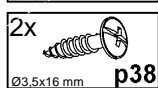
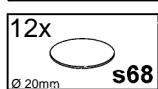
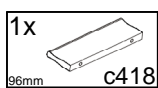
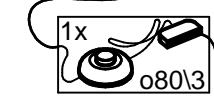
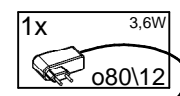
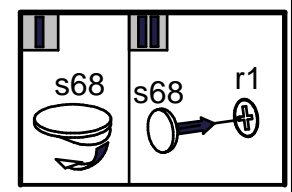
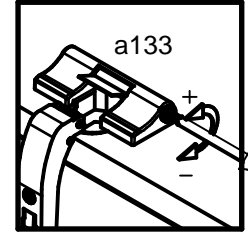
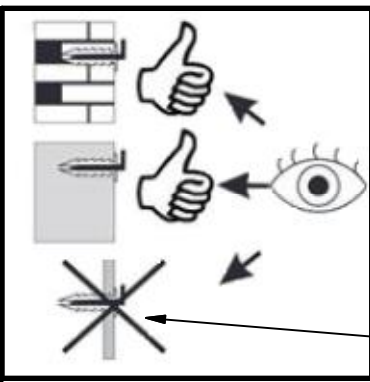
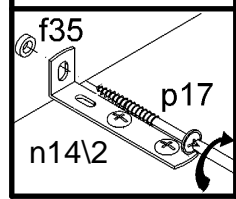
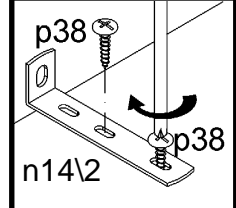
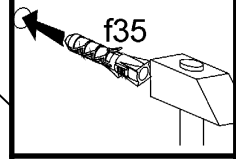
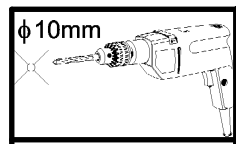
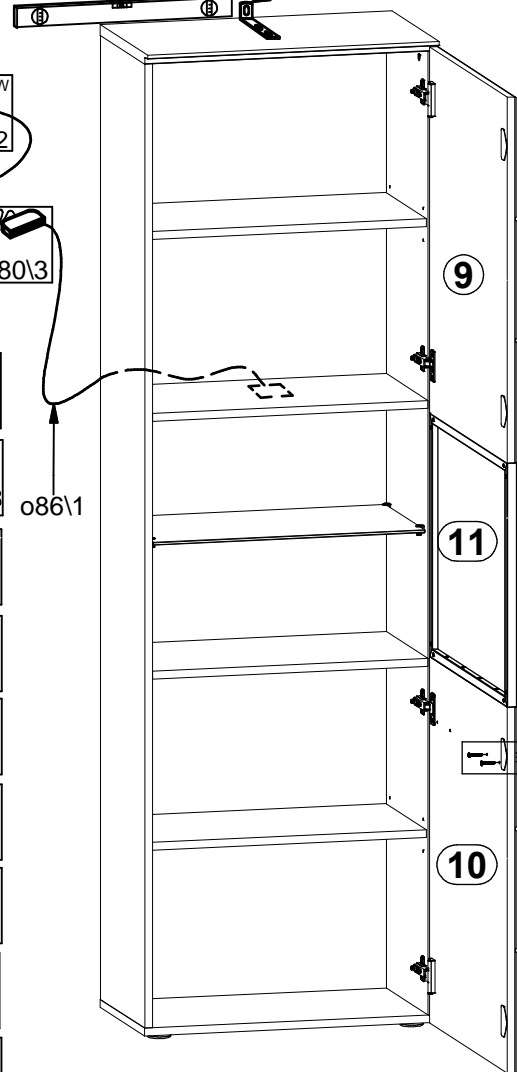
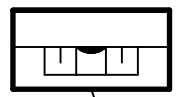

o86\1

