



**A**

**S507-KOM2D4S/9/18**

**10H9--20**

2 / 9

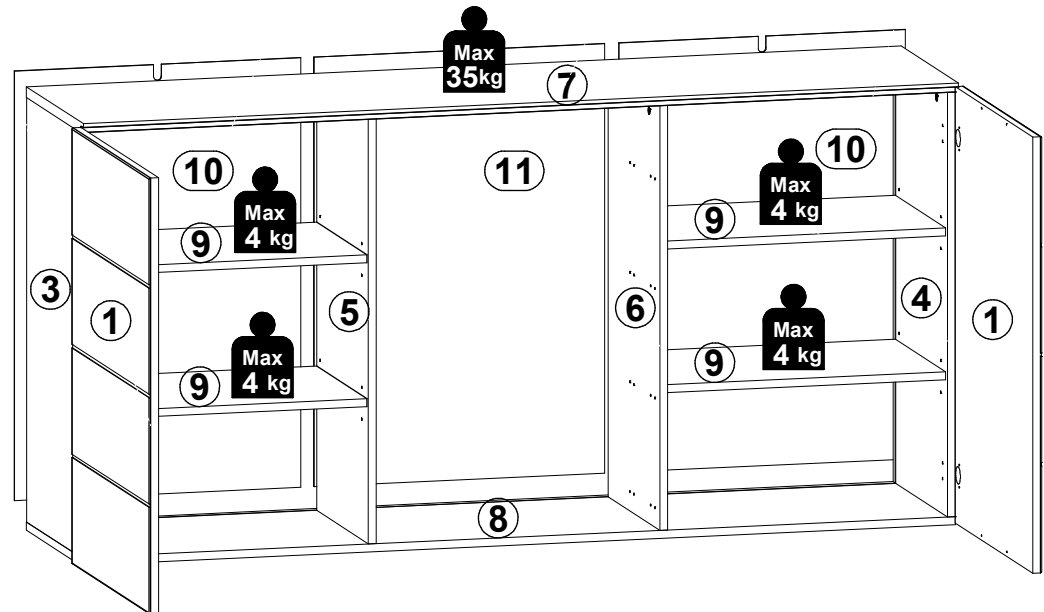
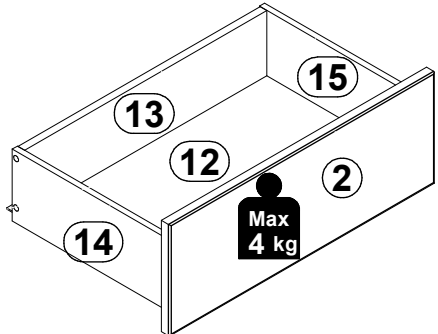
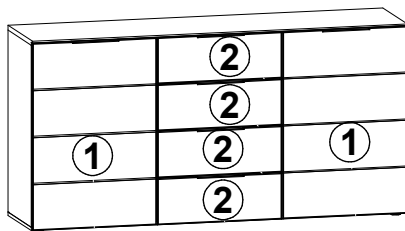
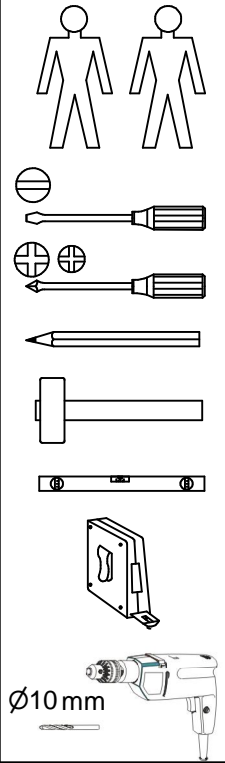

A	B	C1	C2	C3	D
1	S507-0007	880	596	19	3/3
2	S507-0008	217	596	19	3/3
3	S507-1008	856	417	16	2/3
4	S507-1018	856	417	16	2/3
5	S507-1019	856	397	16,	1/3
6	S507-1020	856	397	16,	1/3
7	S507-2012	1800	440	22	2/3
8	S507-2013	1800	418	16	2/3
9	S507-3015	575	387	16	1/3
10	S507-9008	866	589	2,5	3/3
11	S507-9009	866	598	2,5	3/3
12	WSP-9148	554	358	2,5	1/3
13	ZQ6-5024	544	127	15	1/3
14	ZQ6-511	350	140	12	1/3
15	ZQ6-512	350	140	12	1/3

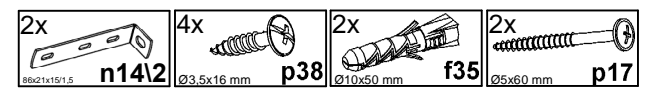
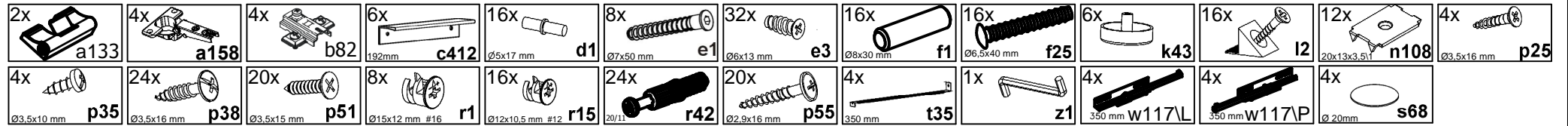

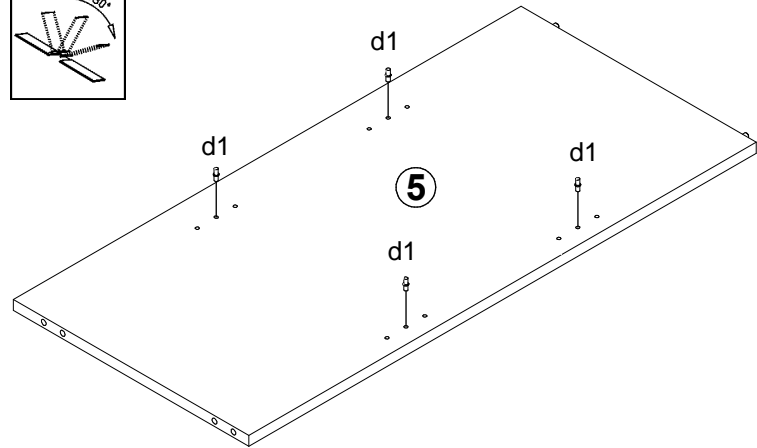
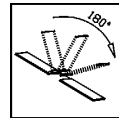
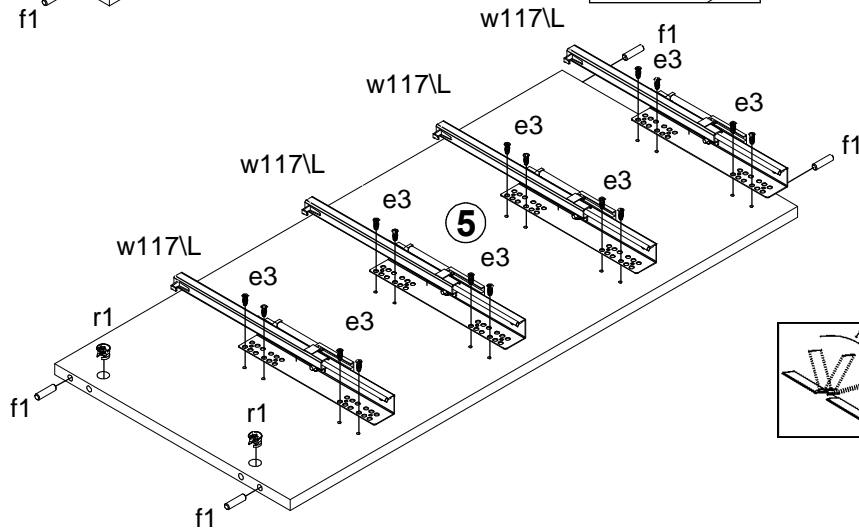
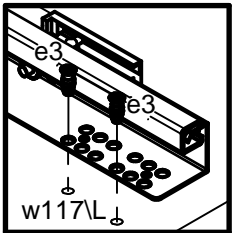
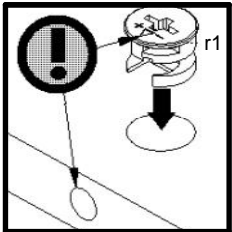
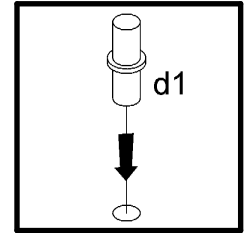
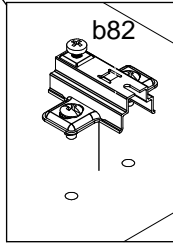
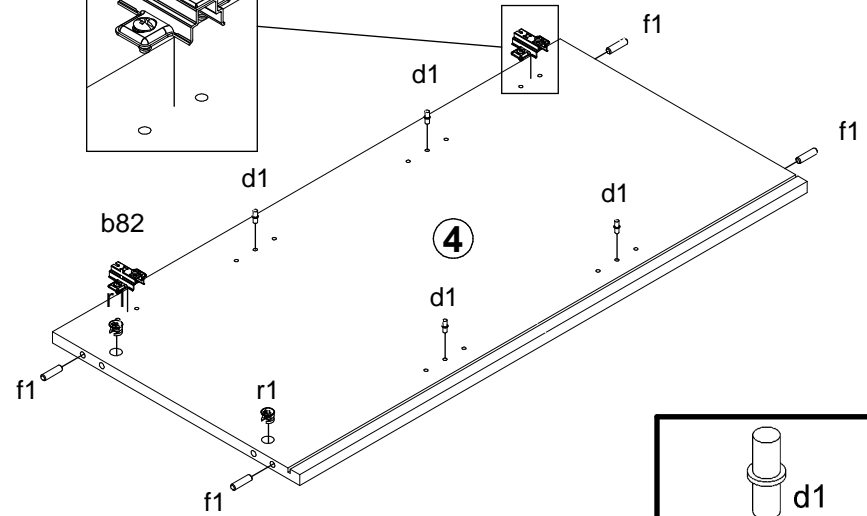
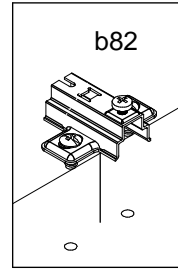
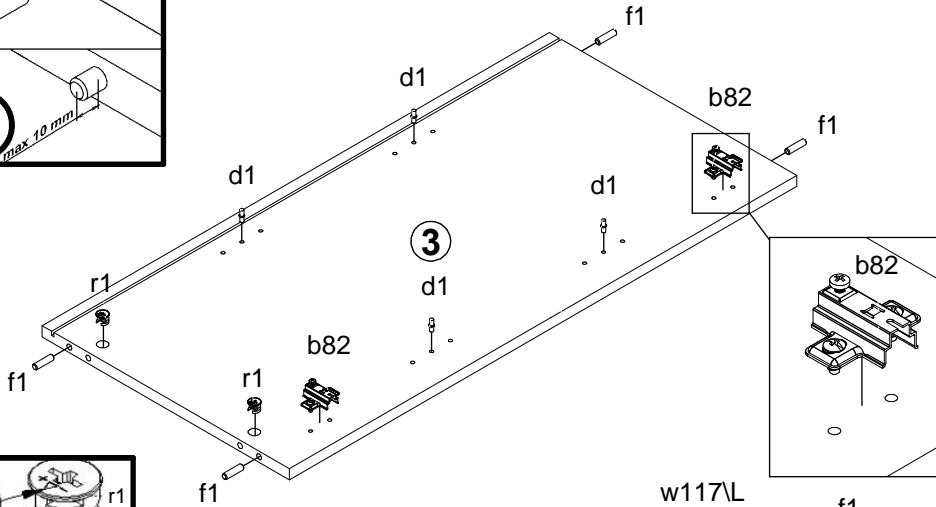
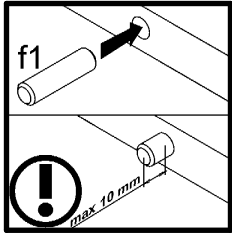

- 4x  
  
350 mm W117\L
- 16x  
  
Ø6x13 mm e3
- 6x  
  
Ø15x12 mm #16 r1
- 12x  
  
Ø5x17 mm d1
- 12x  
  
Ø8x30 mm f1

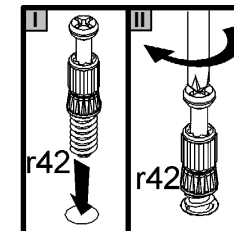
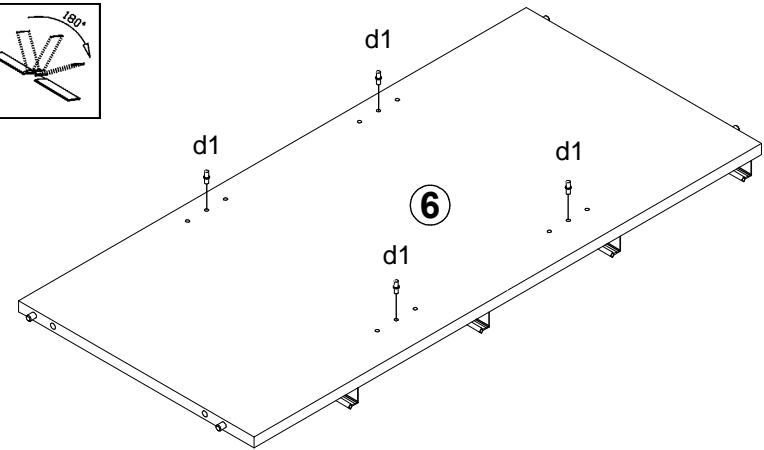
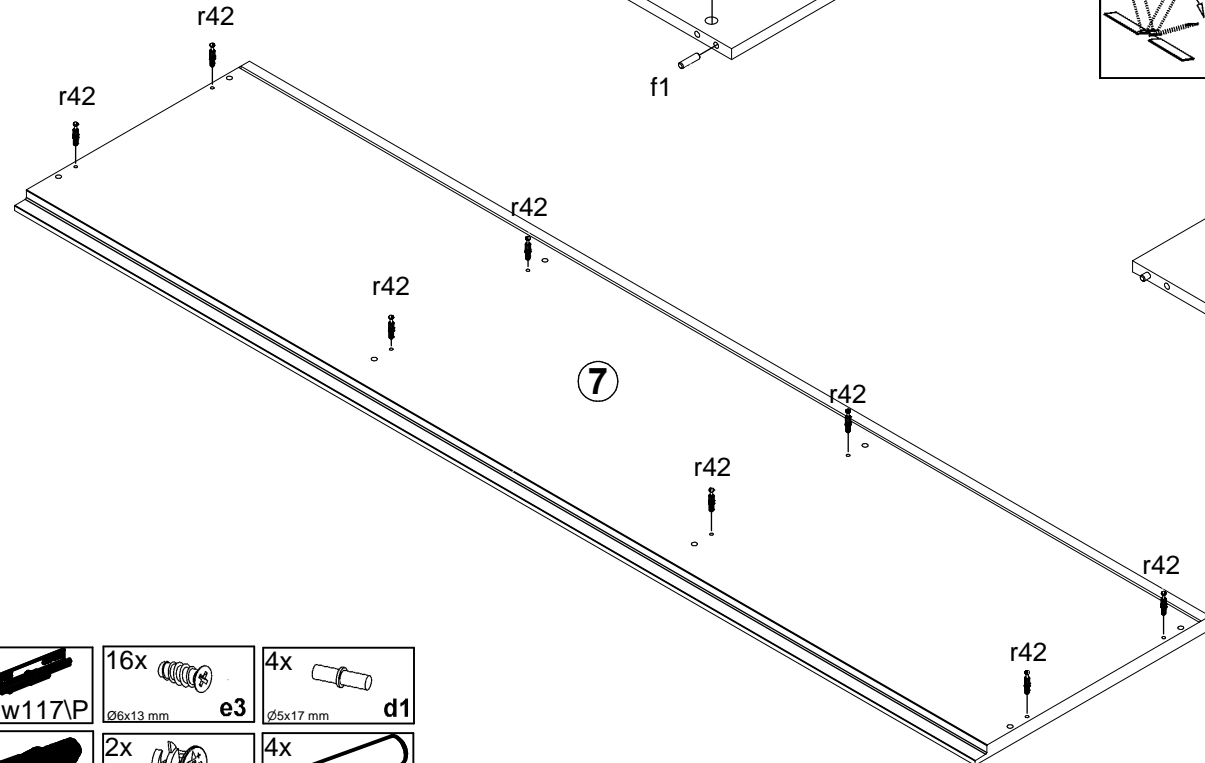
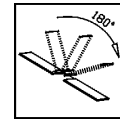
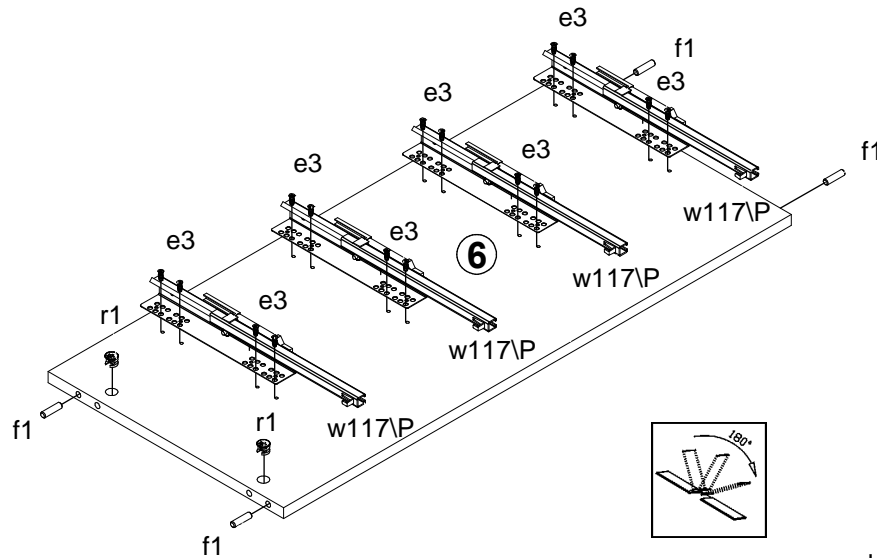
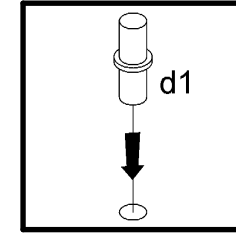
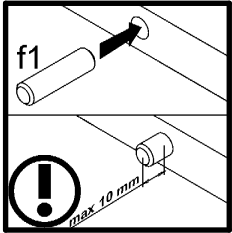
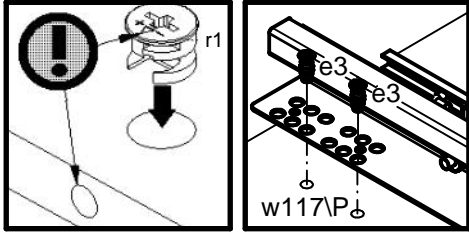

4x 350 mm W117/P	16x Ø6x13 mm e3	4x Ø5x17 mm d1
8x 20/11 r42	2x Ø15x12 mm #16 r1	4x Ø8x30 mm f1

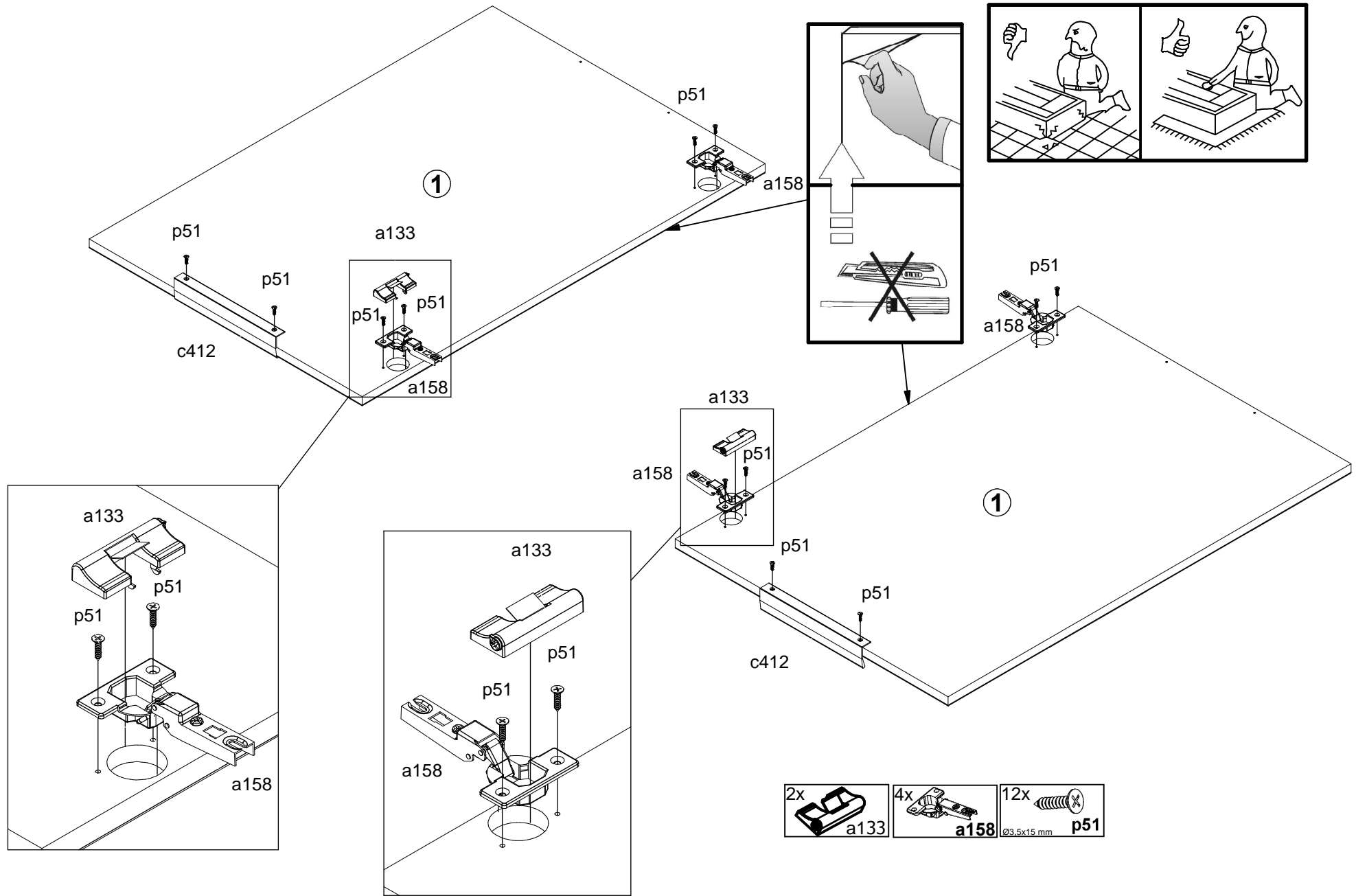

2

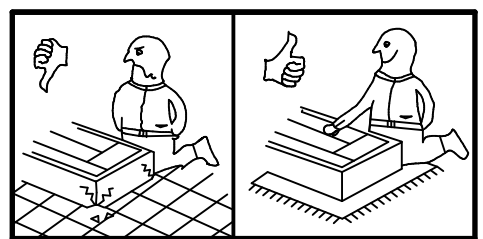
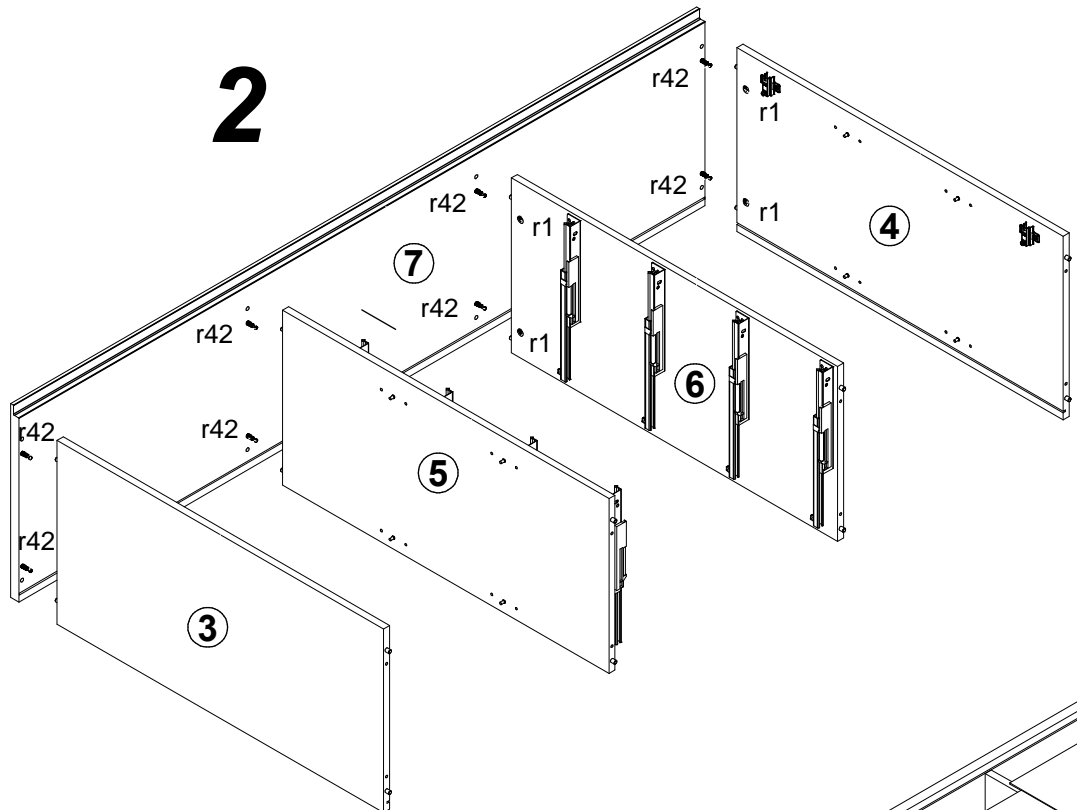

3

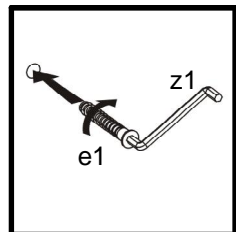
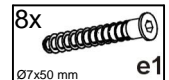
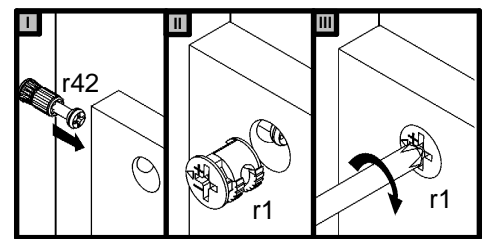
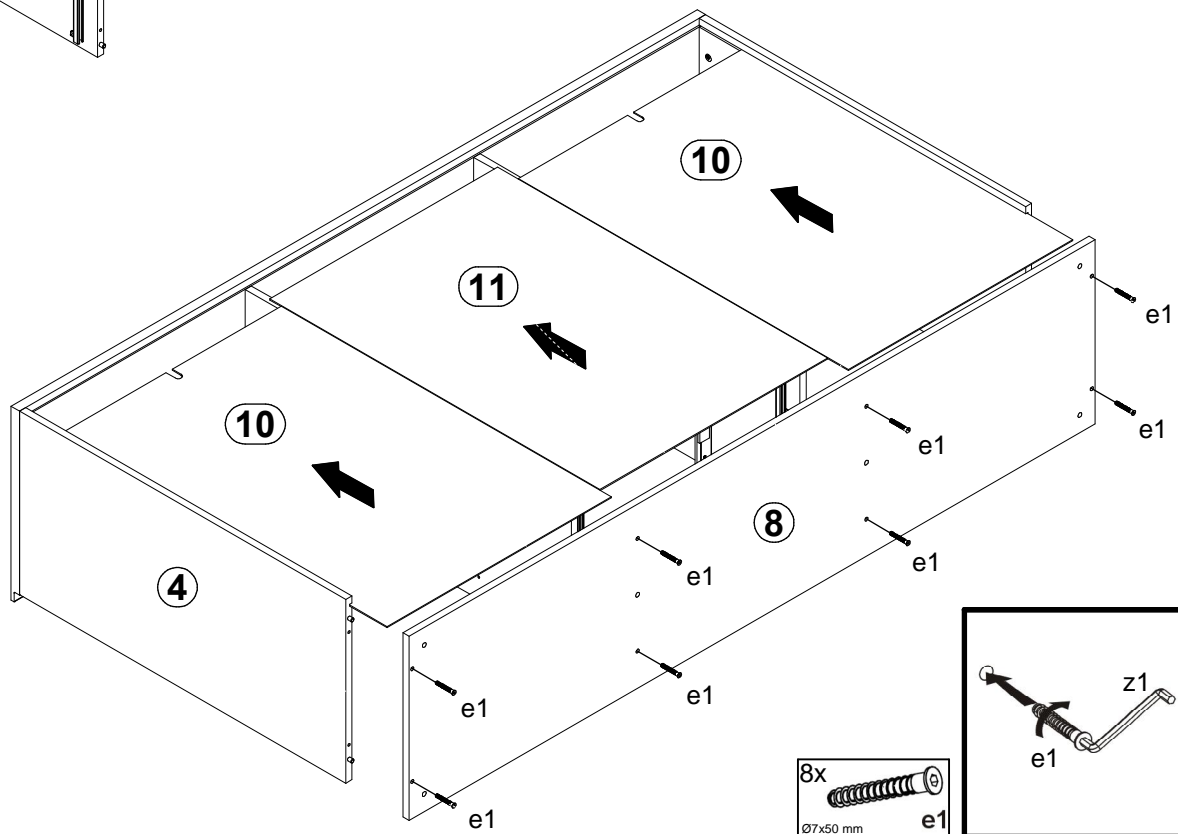



4

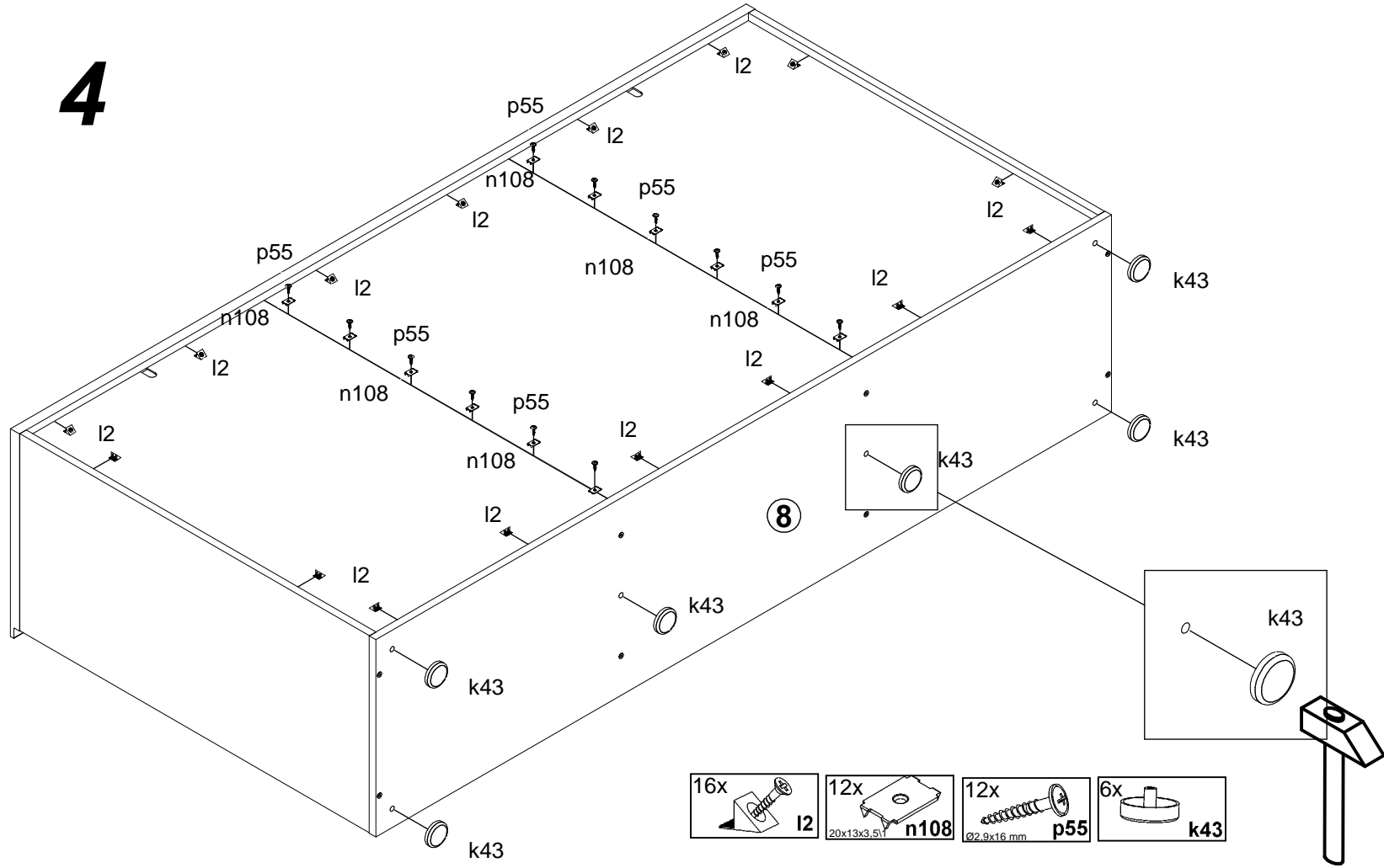

- 16x
l2
- 12x
n108
- 12x
p55
- 6x
k43

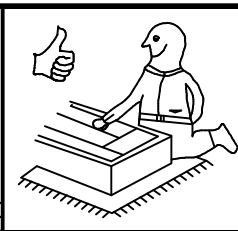
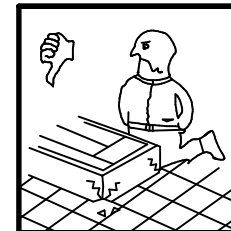
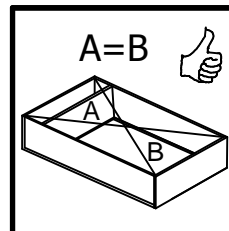
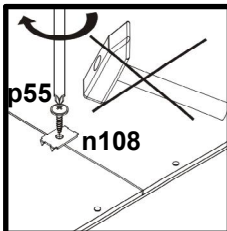
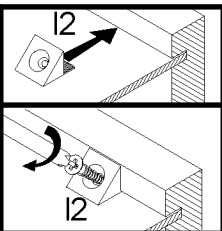
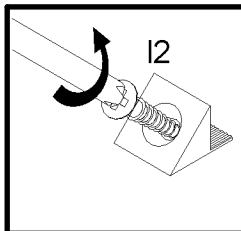
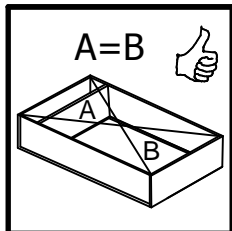

7

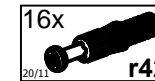
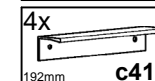
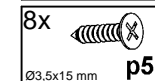
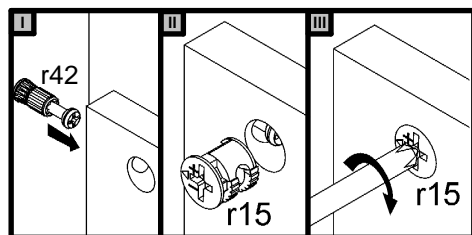
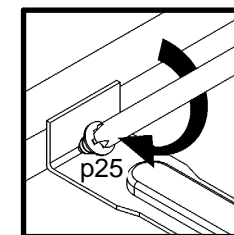
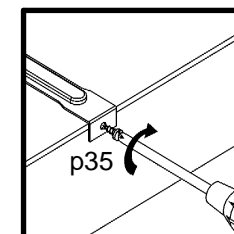
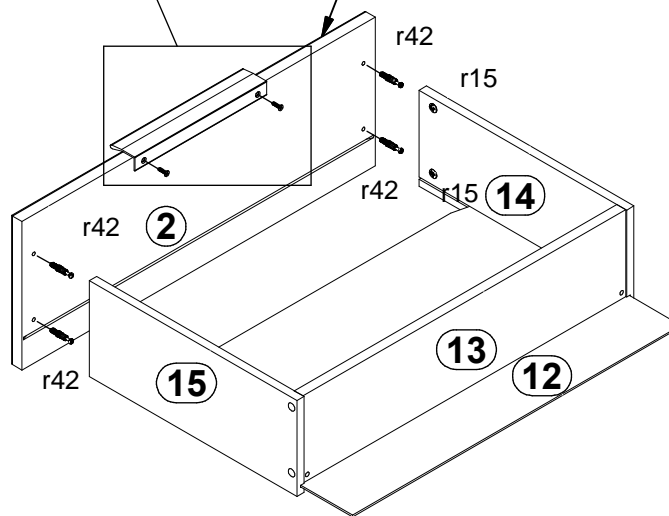
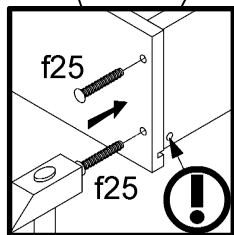
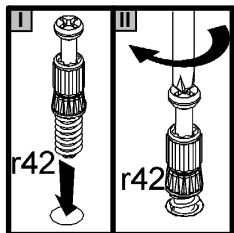
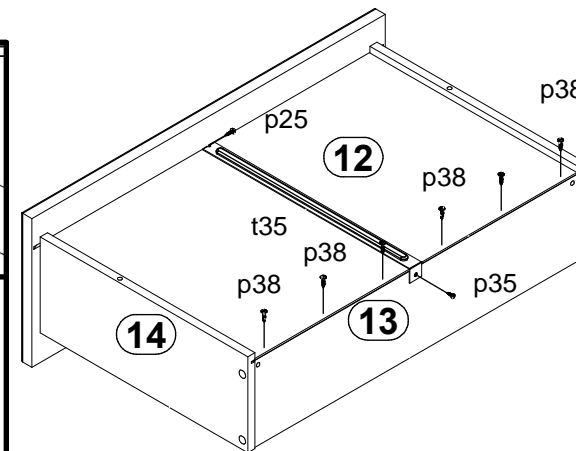
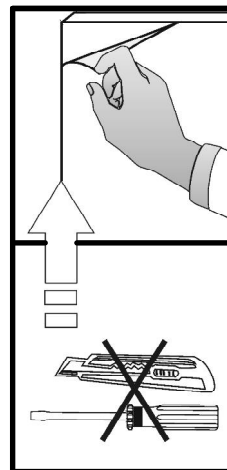
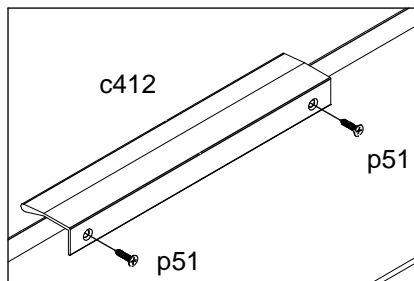
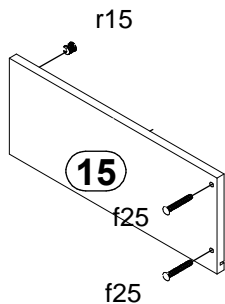
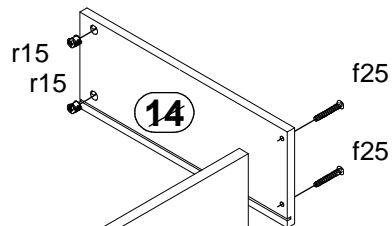
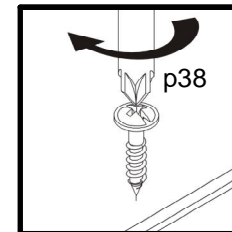
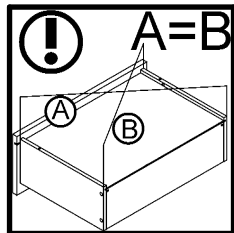
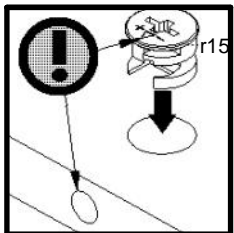



9

