

MONTAGEANLEITUNG / SERVICEKARTE









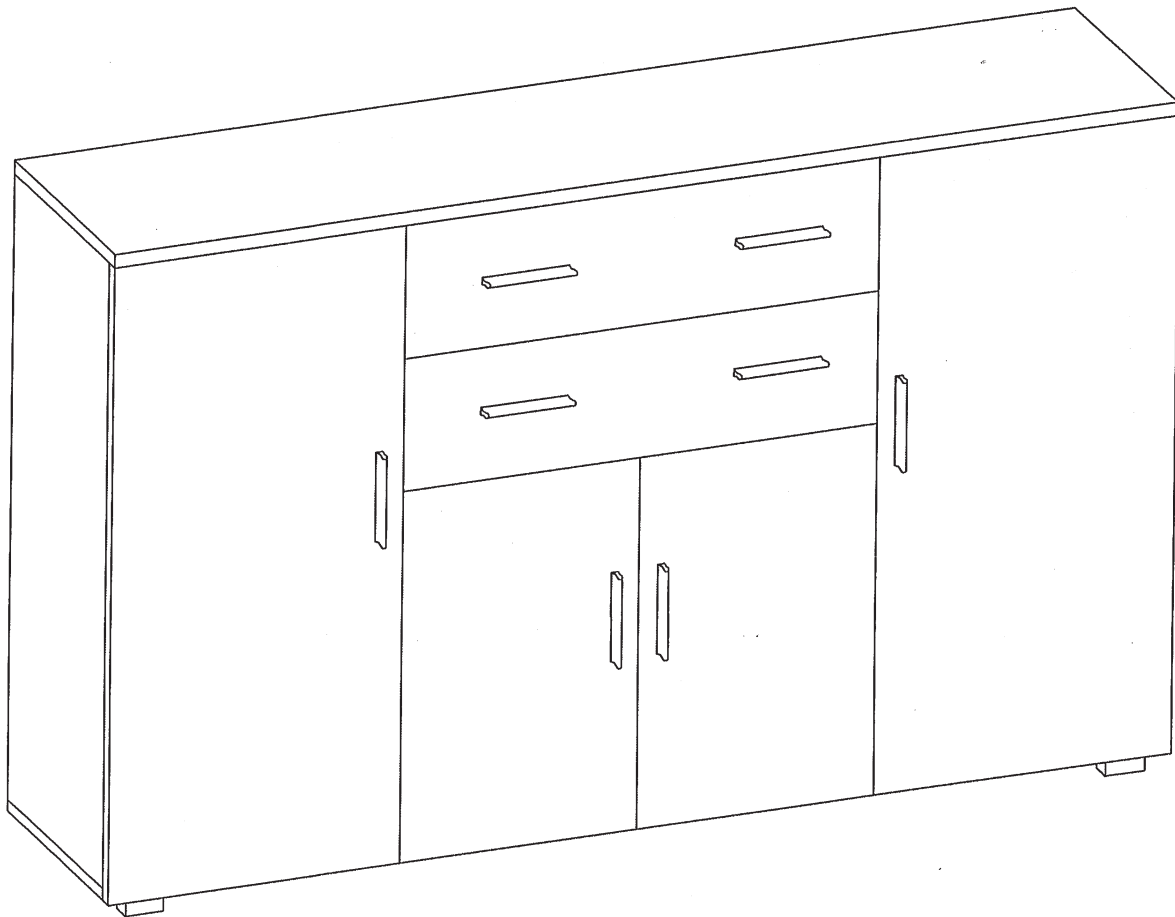

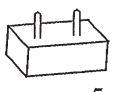

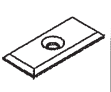
MONTAGEANLEITUNG SOLLTE NICHT ALS TECHNISCHE DOKUMENTATION BETRACHTET WERDEN. AUFBAUANDEUTUNGEN VOM PRODUZENTEN VORBEHALTEN

SEHR GEEHTER KUNDE, SOLLTE EIN TEIL FAHLEN ODER BESCHADIGT SEIN, KREUZEN SIE BITTE DIESES DEUTLICH AUF DER SERVICEKARD AN UND SCHICKEN SIE UNS DIE SERVICEKARD ZURUCK.

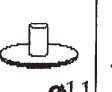
DEN KLEBER BENUTZEN SIE NUR ZUM VERLEIMEN DER SCHUBLADEN.

UM DIE EVENTUELLEN REKLAS RICHTING ZU ERLEDIGEN, BITTEN WIR UM EINE KOPIE DES AUFKLEBERS VON DER WARE, ODER UM ANGABE DER PRODUKTIONSWOCHE.

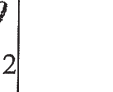
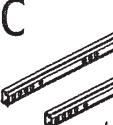

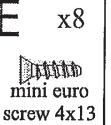
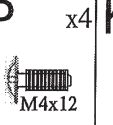
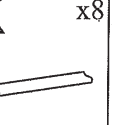
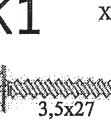
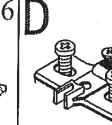
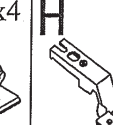
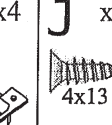
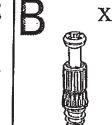
N  x5	R x1 	L x10 	U x110 	G x20 	W x12 	W1 x12  Ø11	O x1 	A x28 	S x12 	S1 x12  Ø16
C x2 	E x8  mini euro screw 4x13	P x4  M4x12	K x8 	K1 x16  3,5x27	D x4 	H x4 	J x8  4x13	B x12 	H1 x4 	

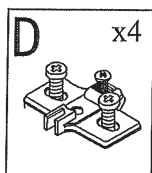
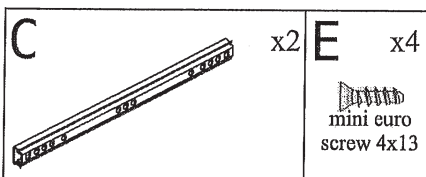
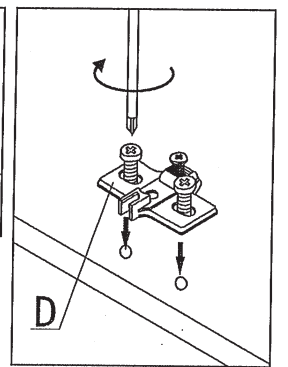
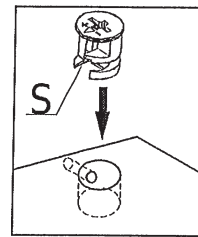
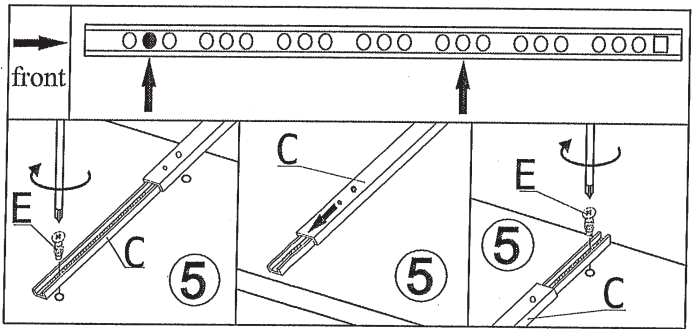
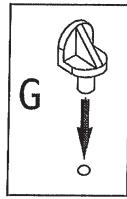
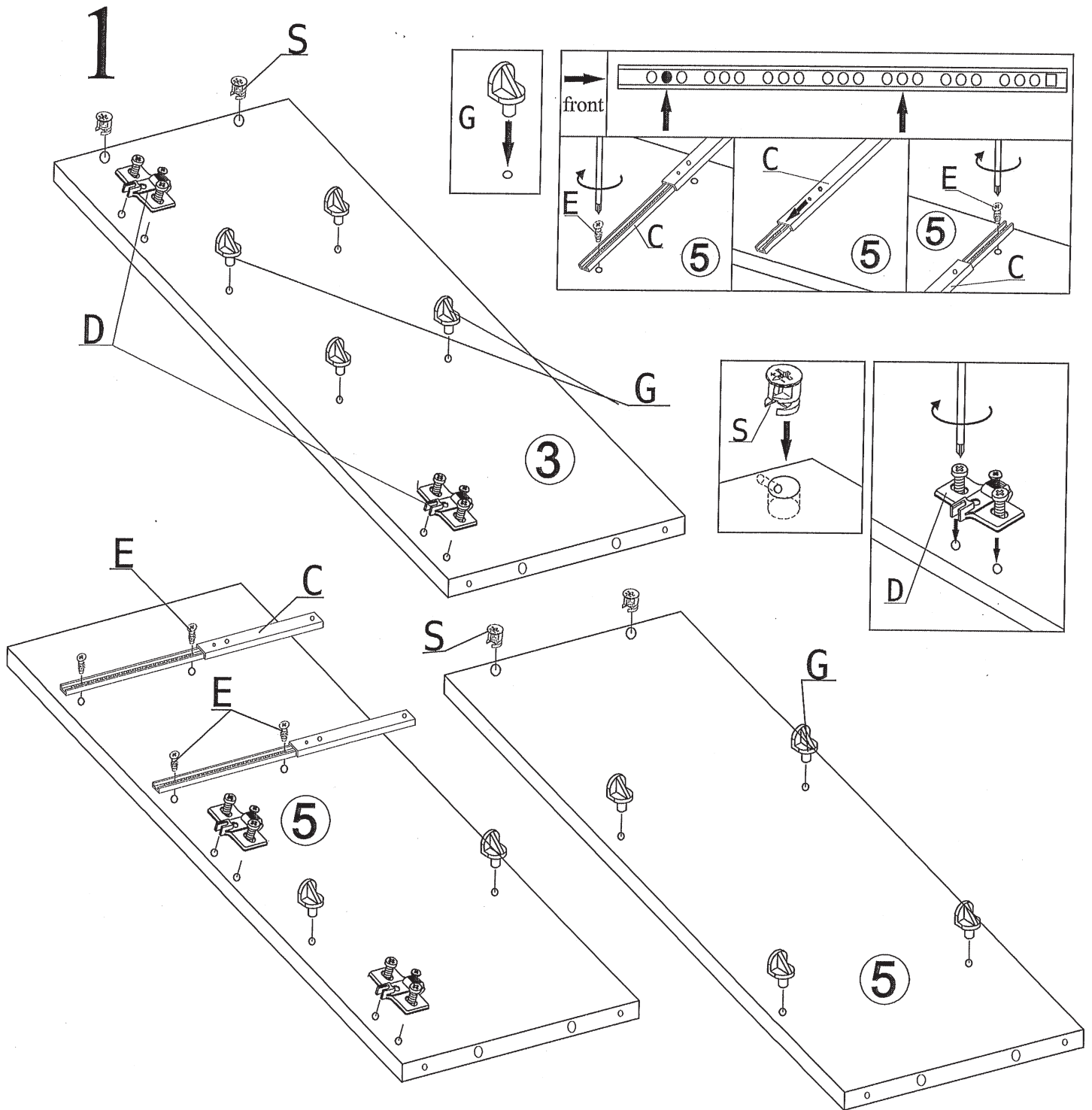

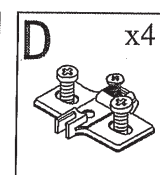
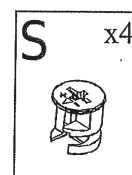
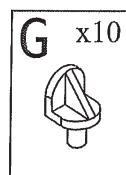
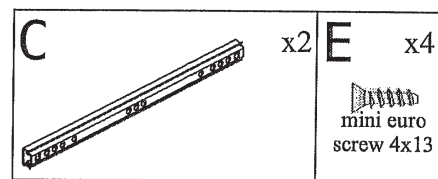
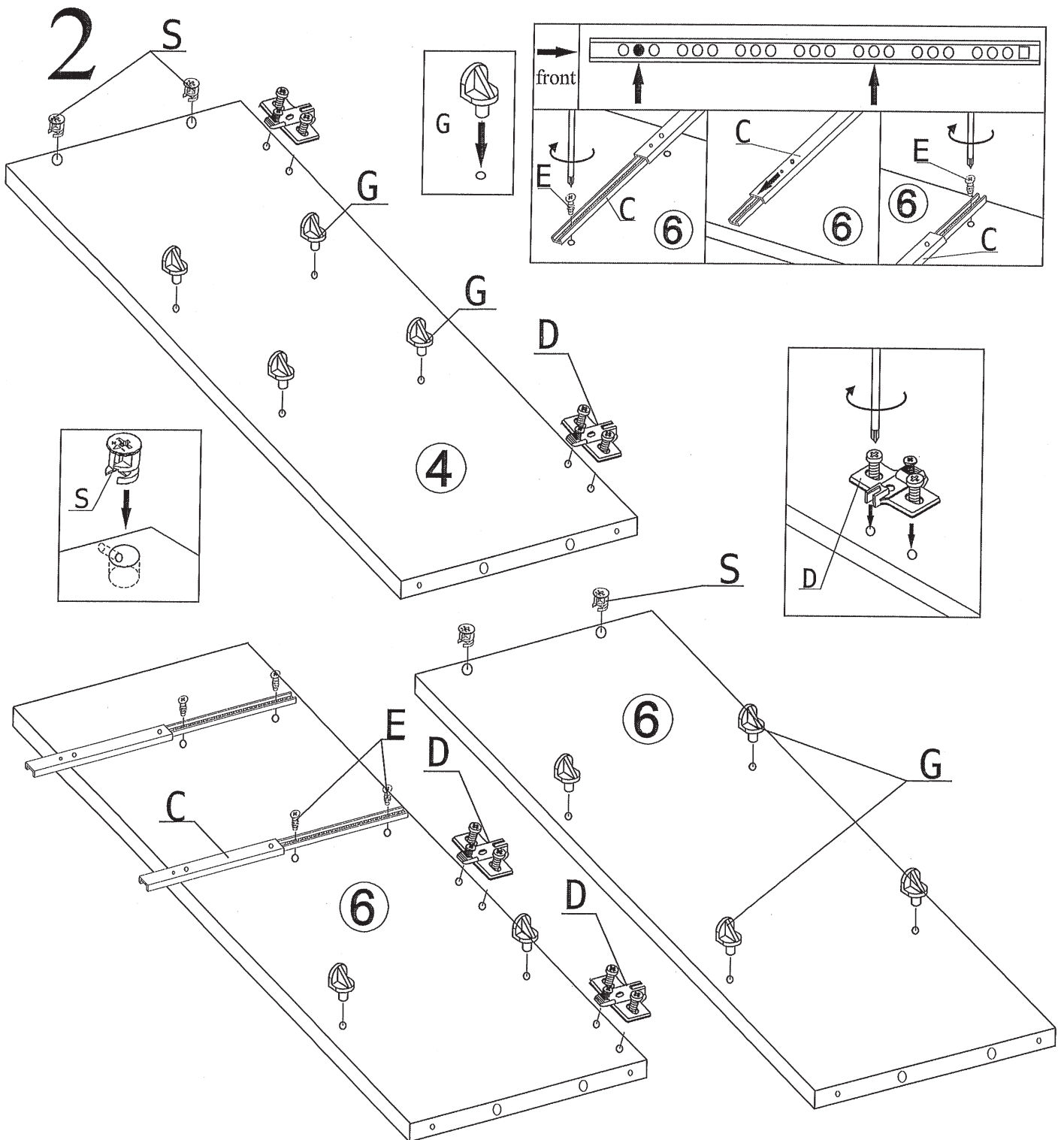

3

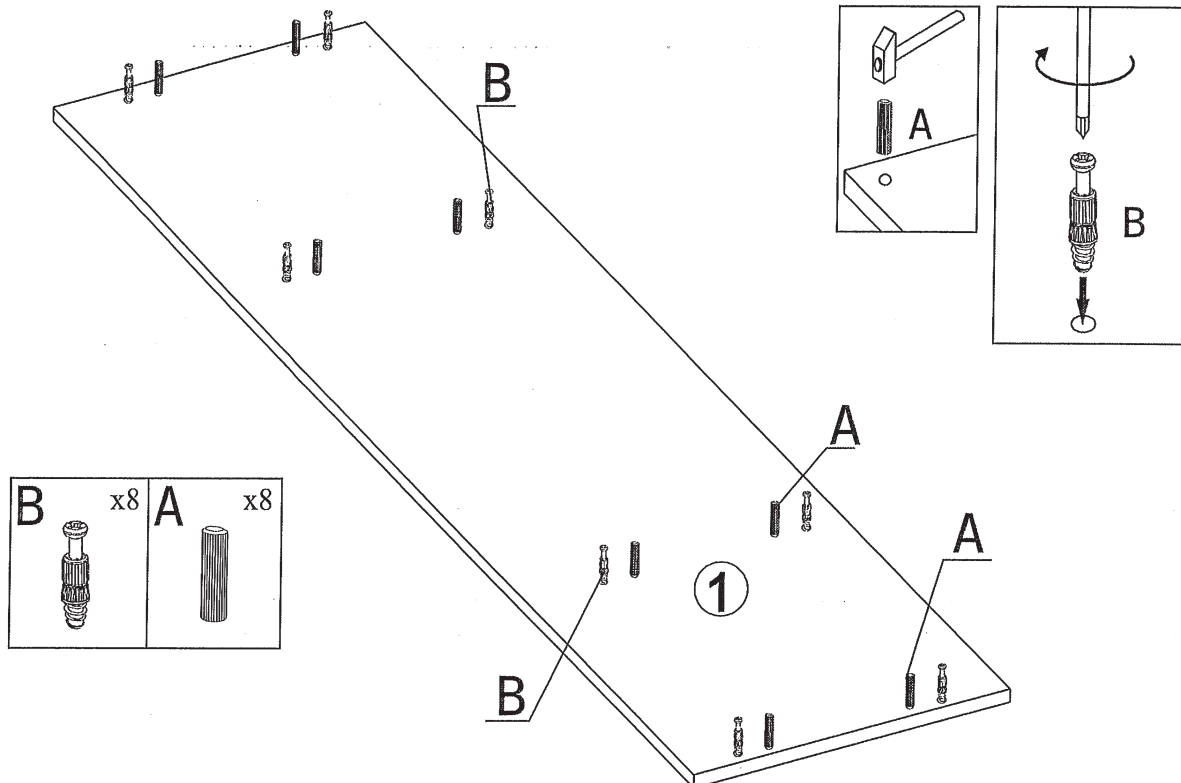

4

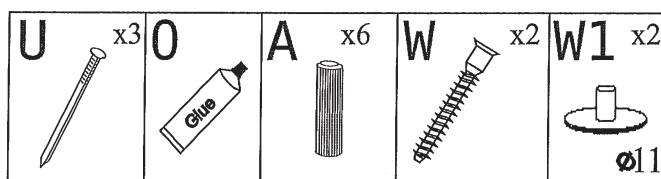

x2

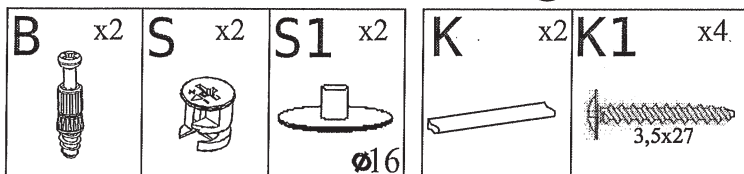
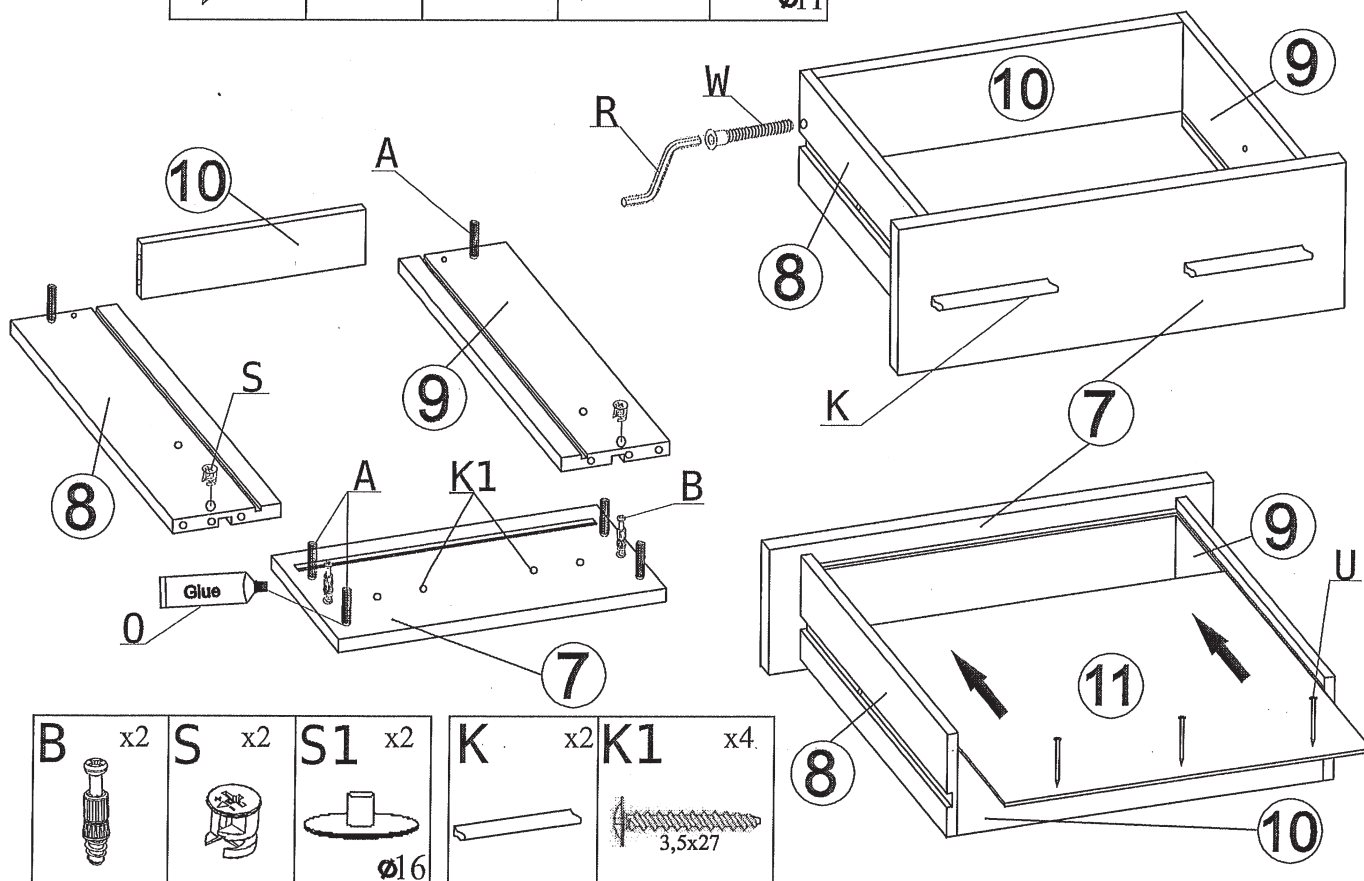

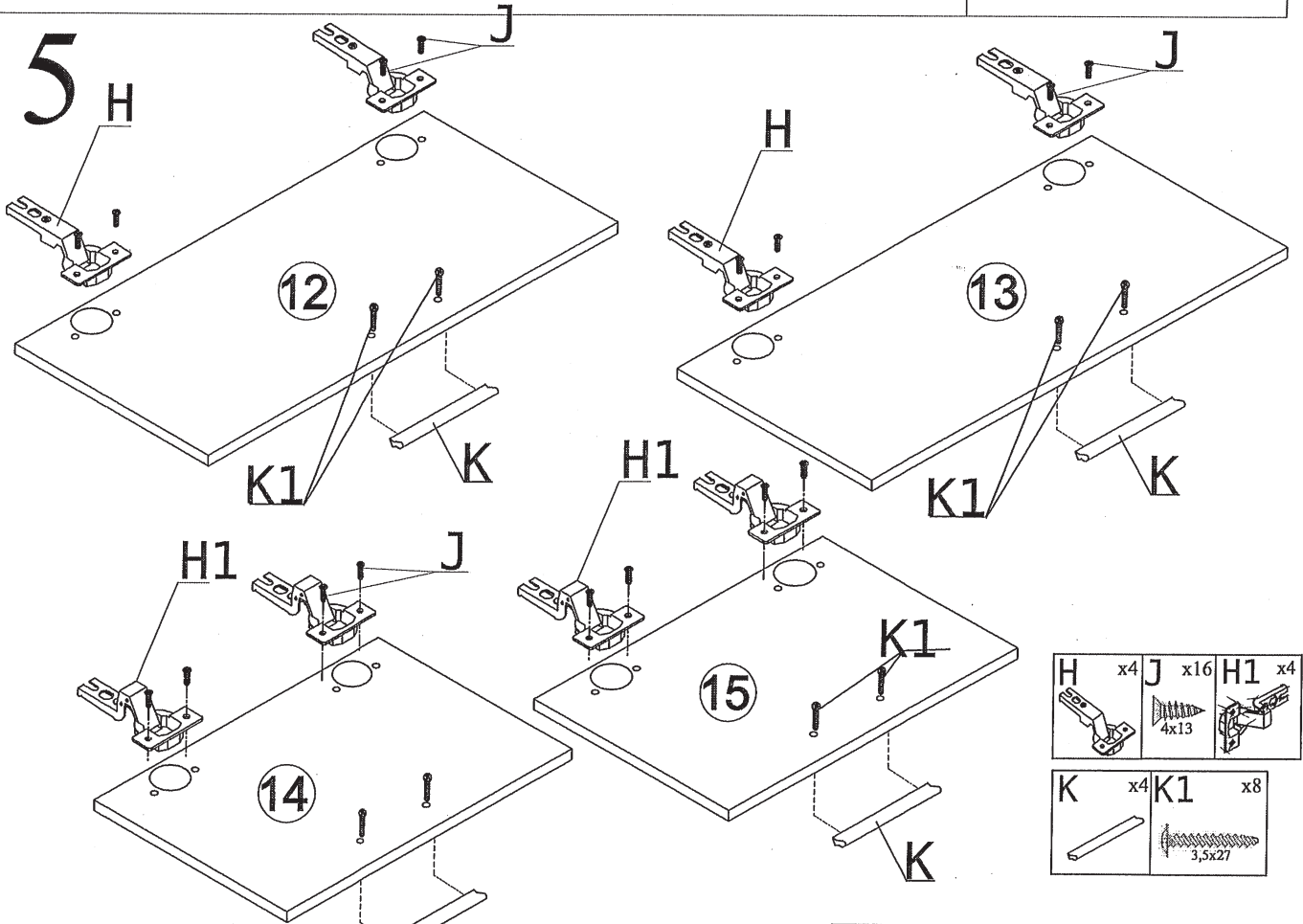

6

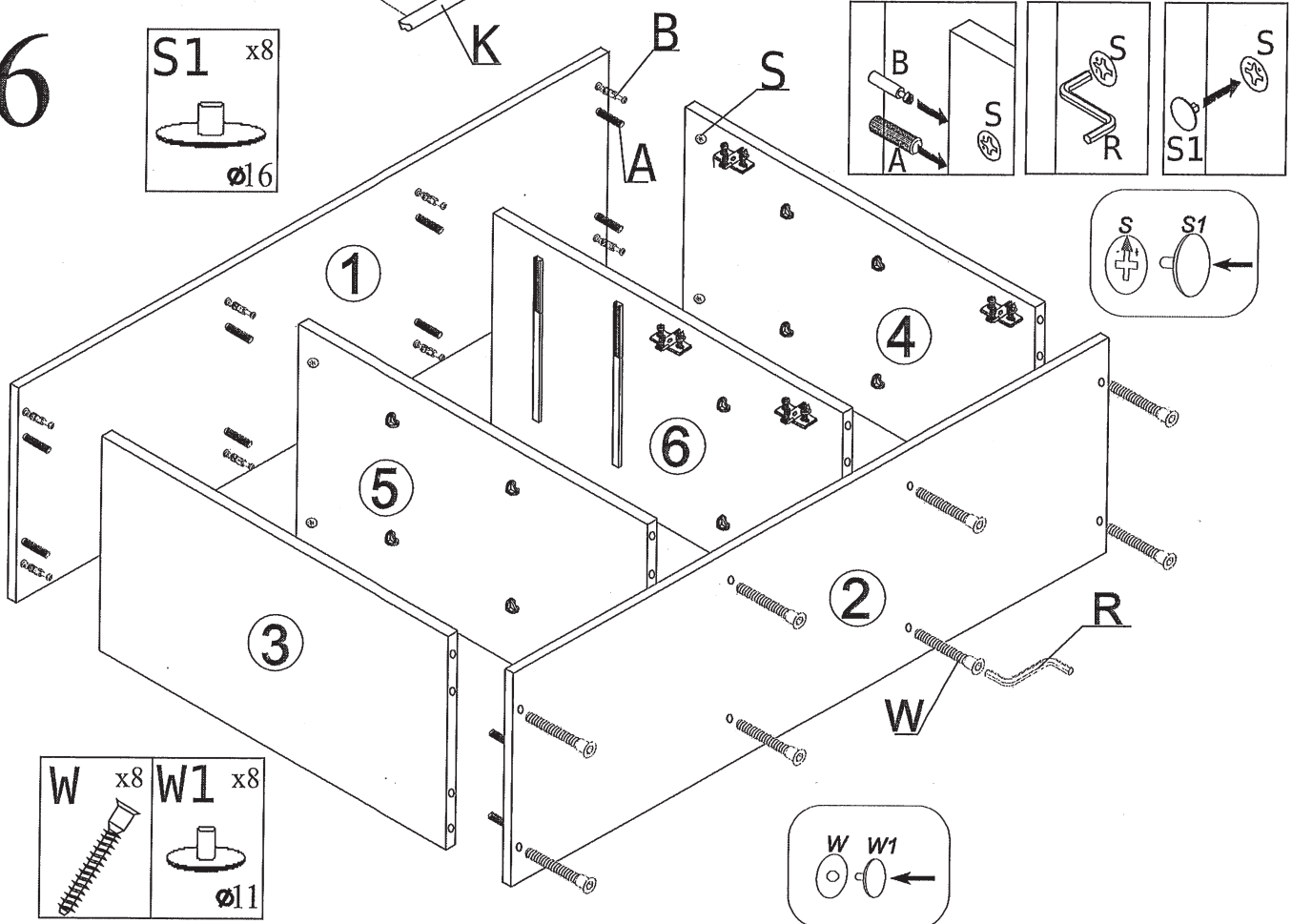

7

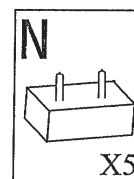
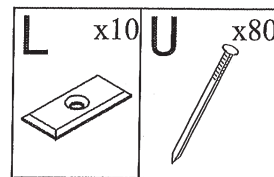
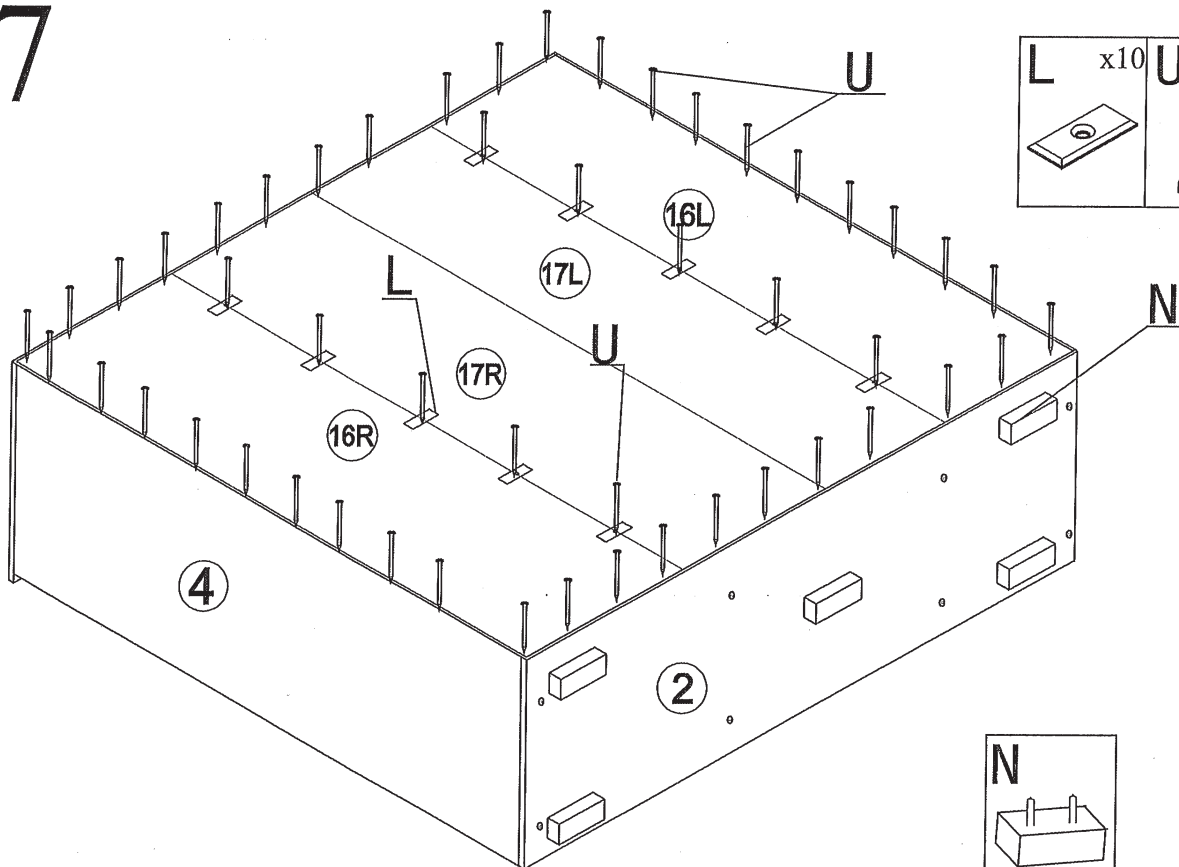

8

