

A	B	C1	C2	C3	D
1	M245-0002	412	546	16	1/1
2	M245-1003	824	347	16	1/1
3	M245-1004	824	347	16	1/1
5	M245-2001	550	370	16	1/1
6	M245-3004	517	347	16	1/1
7	M245-3005	517	327	16	1/1
8	M245-3006	516	290	16	1/1
10	M245-9301	817	527	2,5	1/1

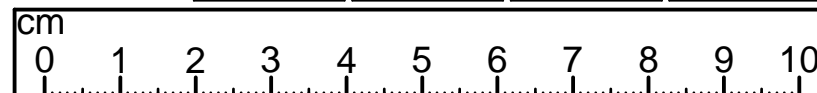

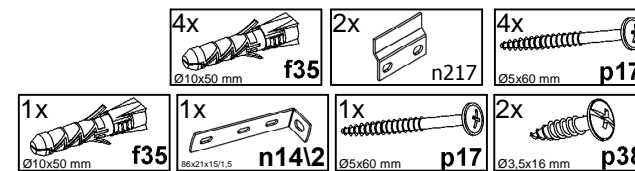

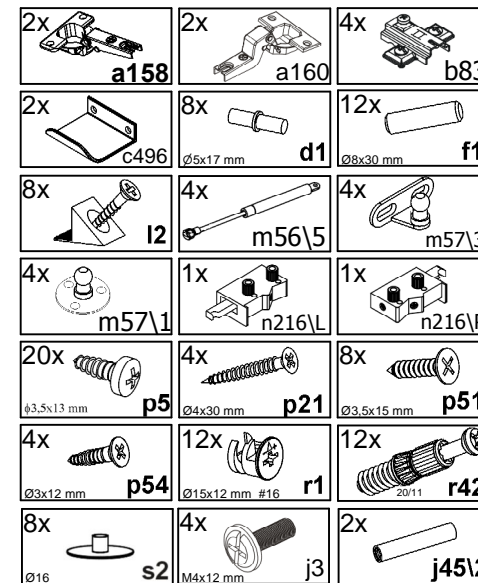
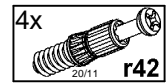
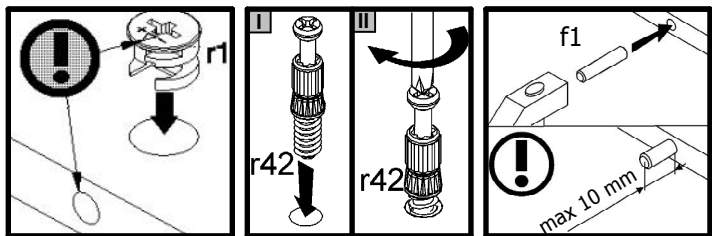
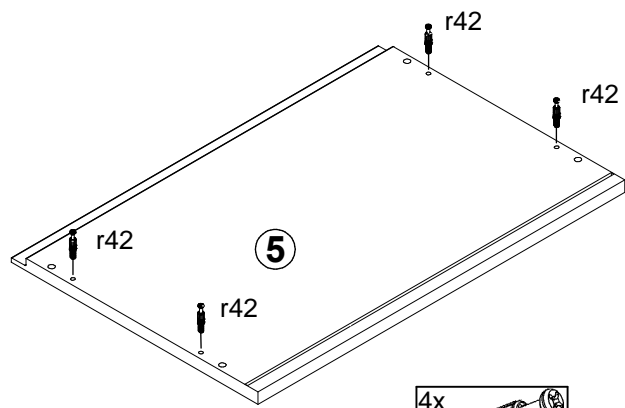
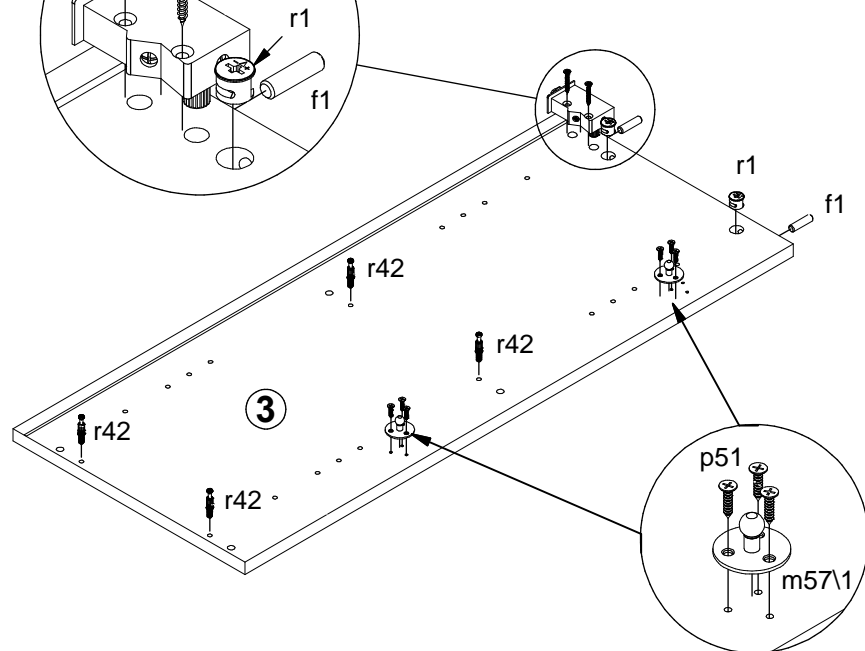
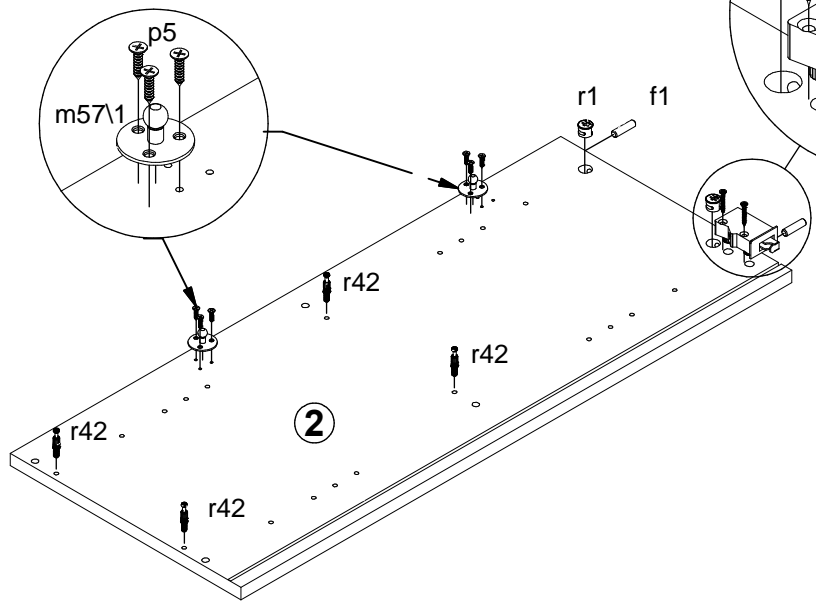
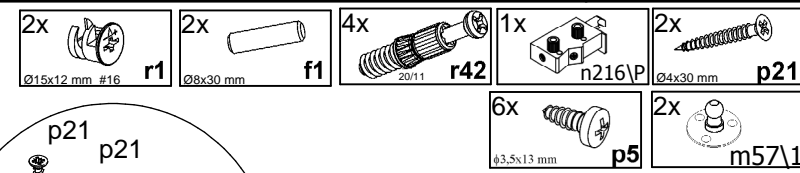
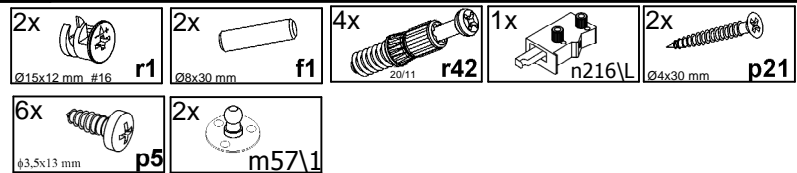
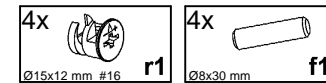
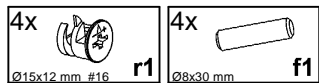

1

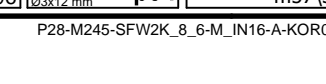
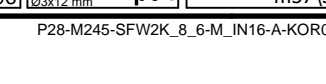
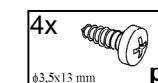
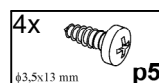
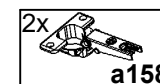
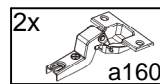
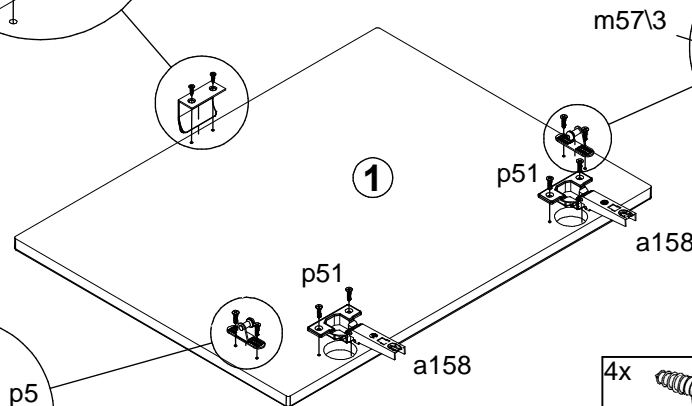
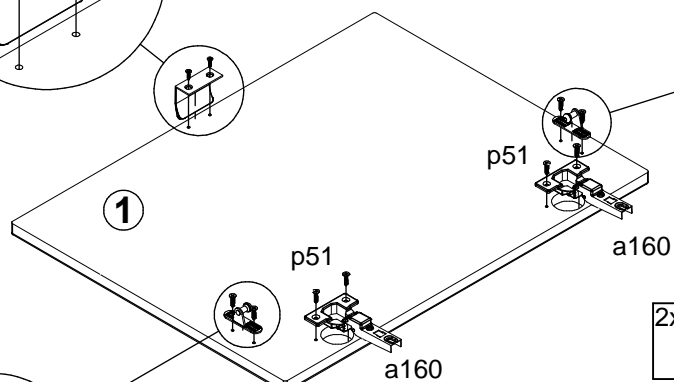
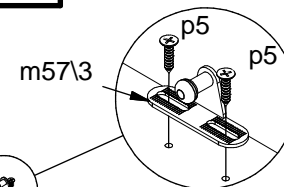
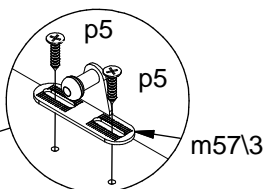
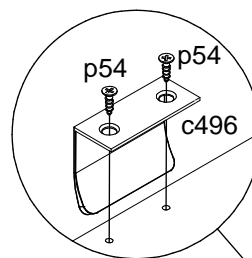
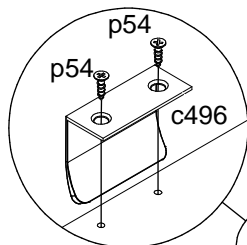
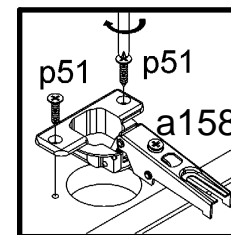
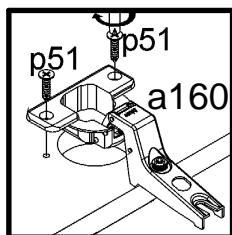
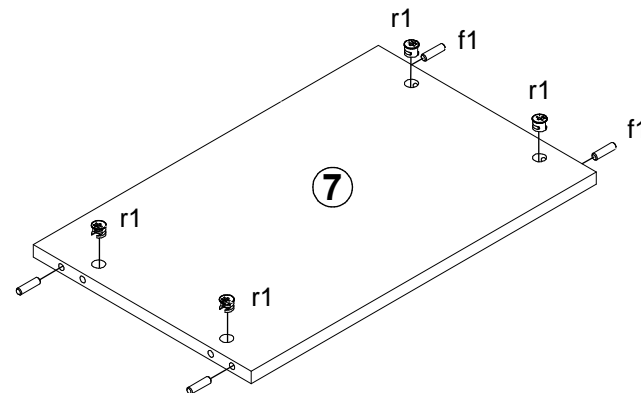
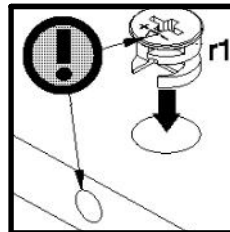
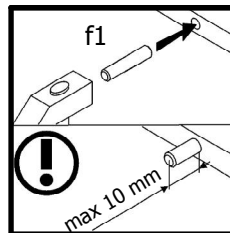
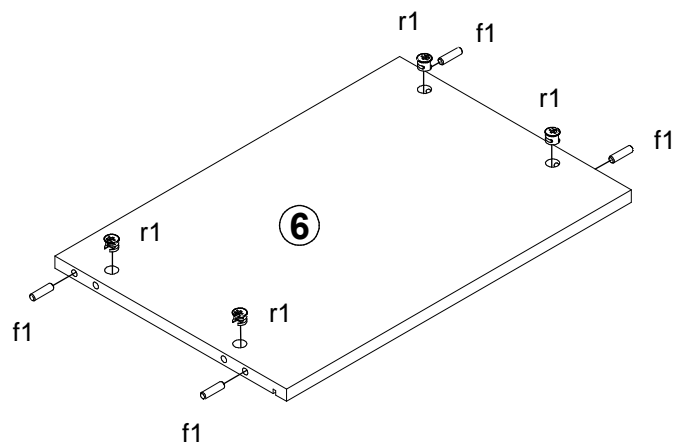

2

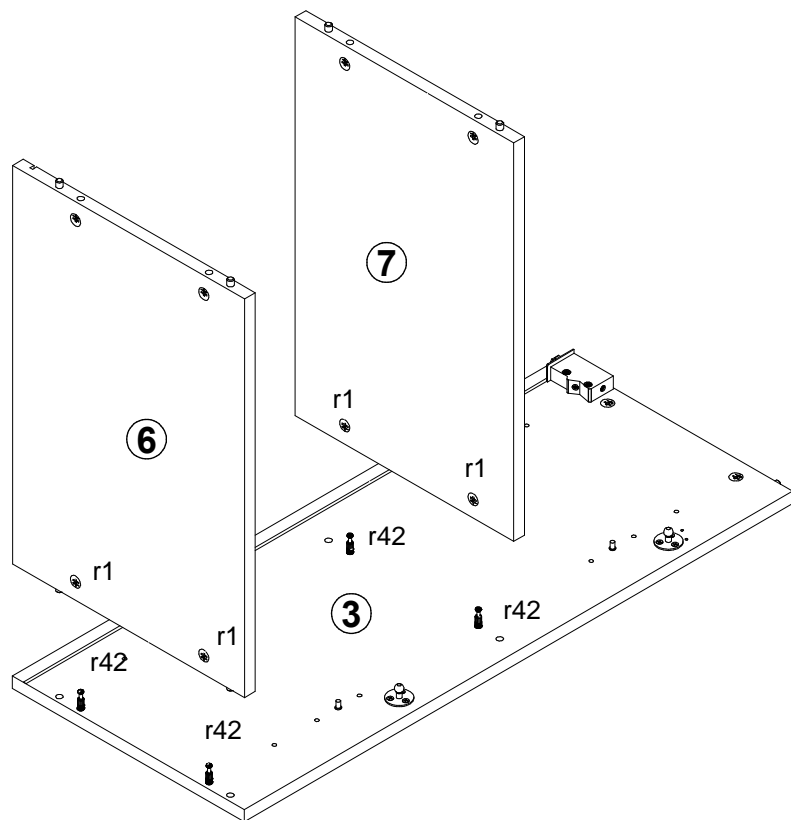

3

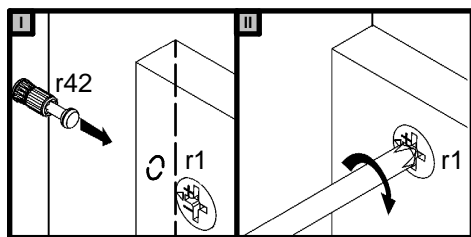
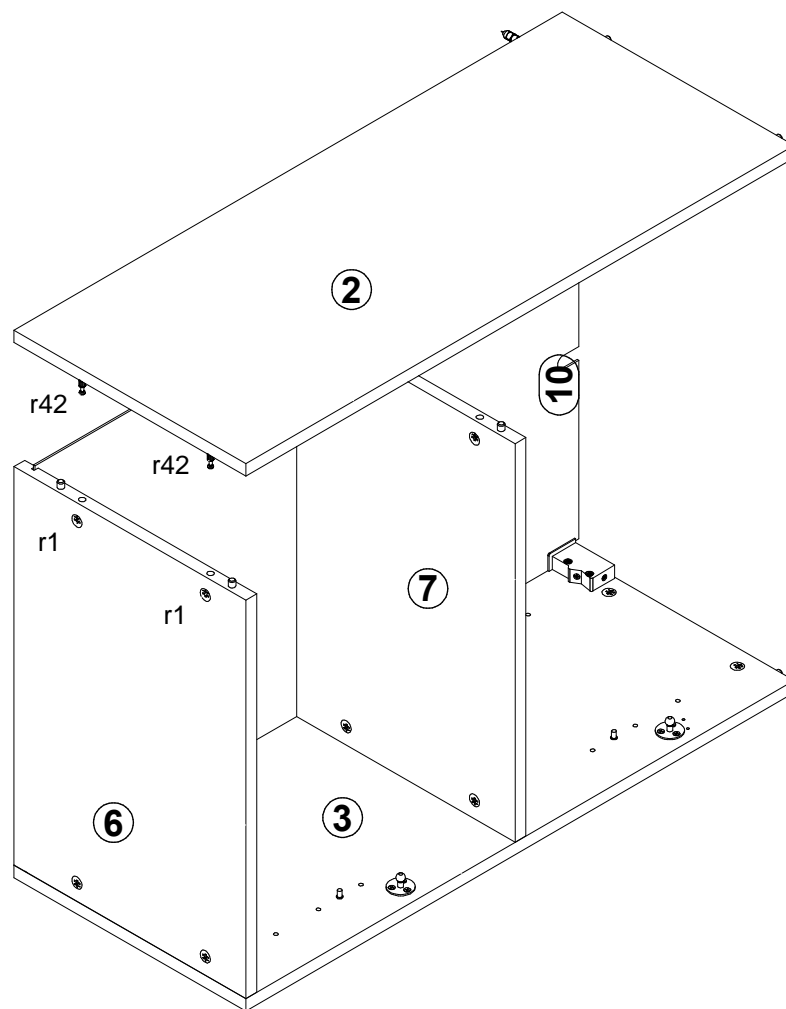

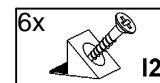
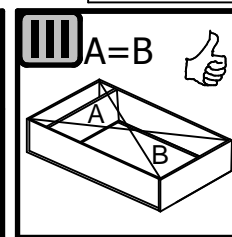
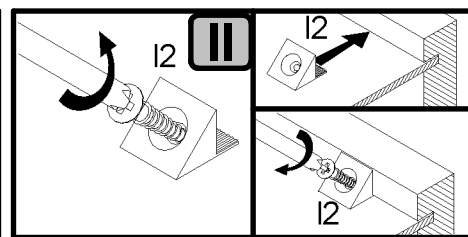
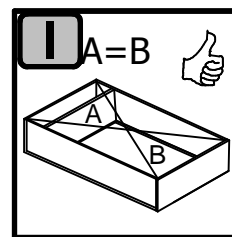
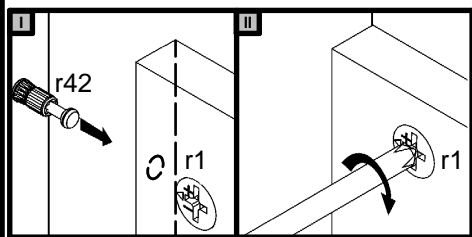
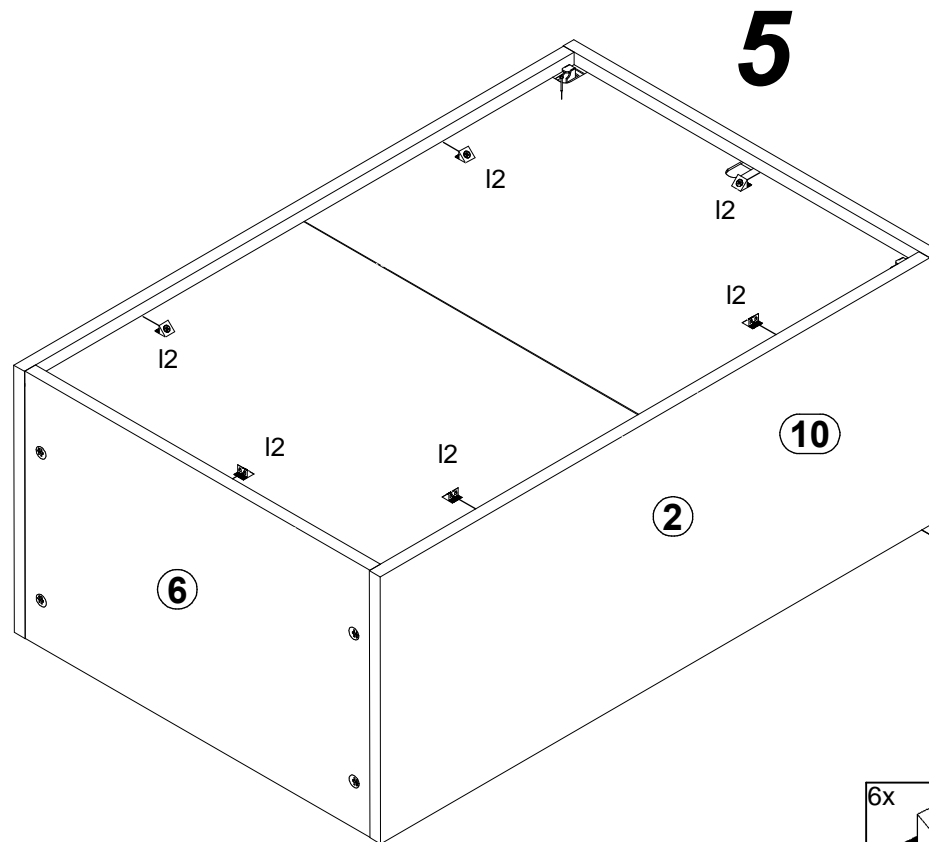
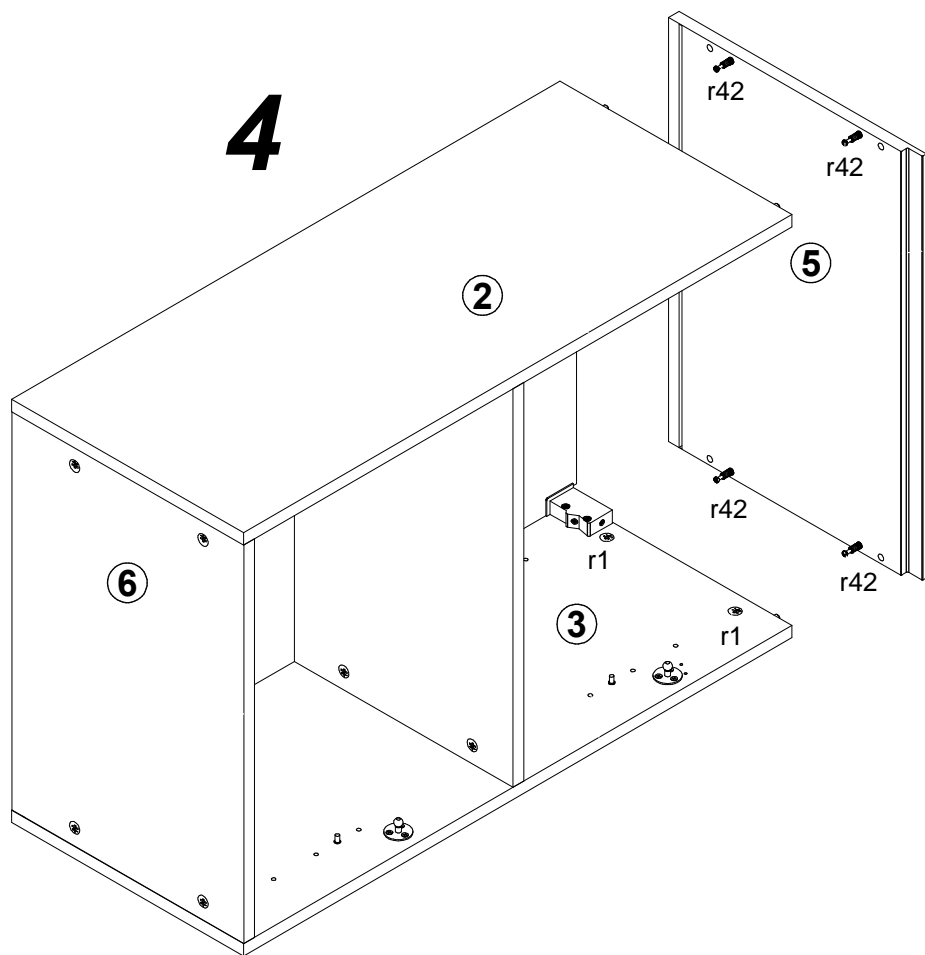

6

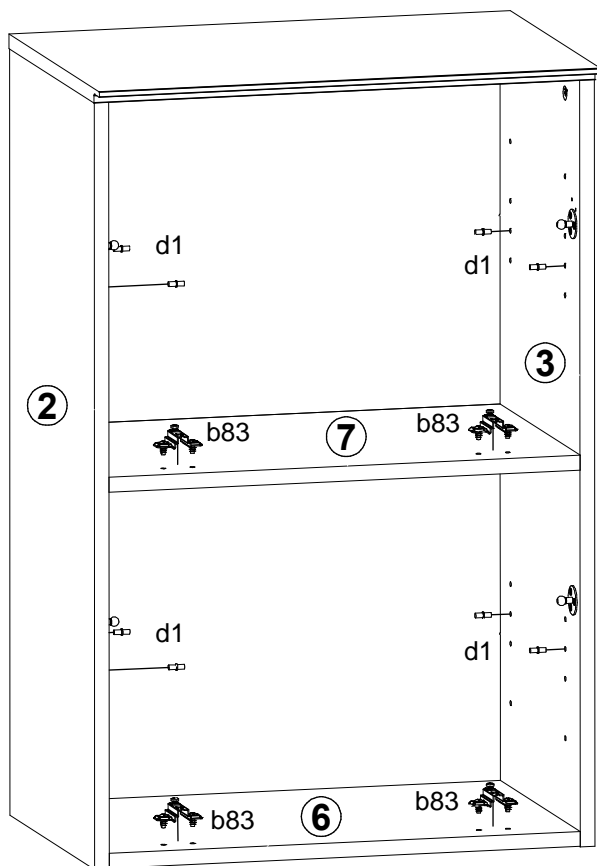

7

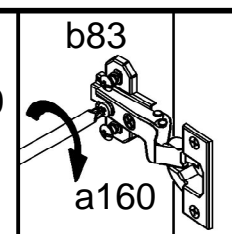
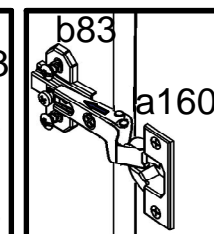
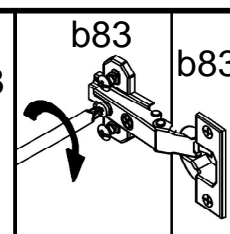
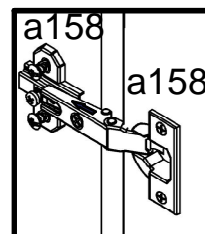
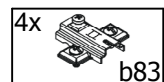
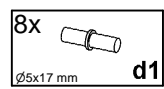
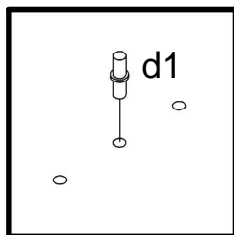
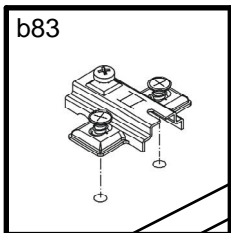
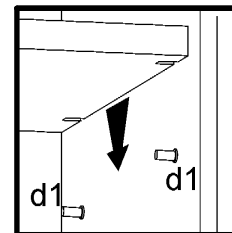
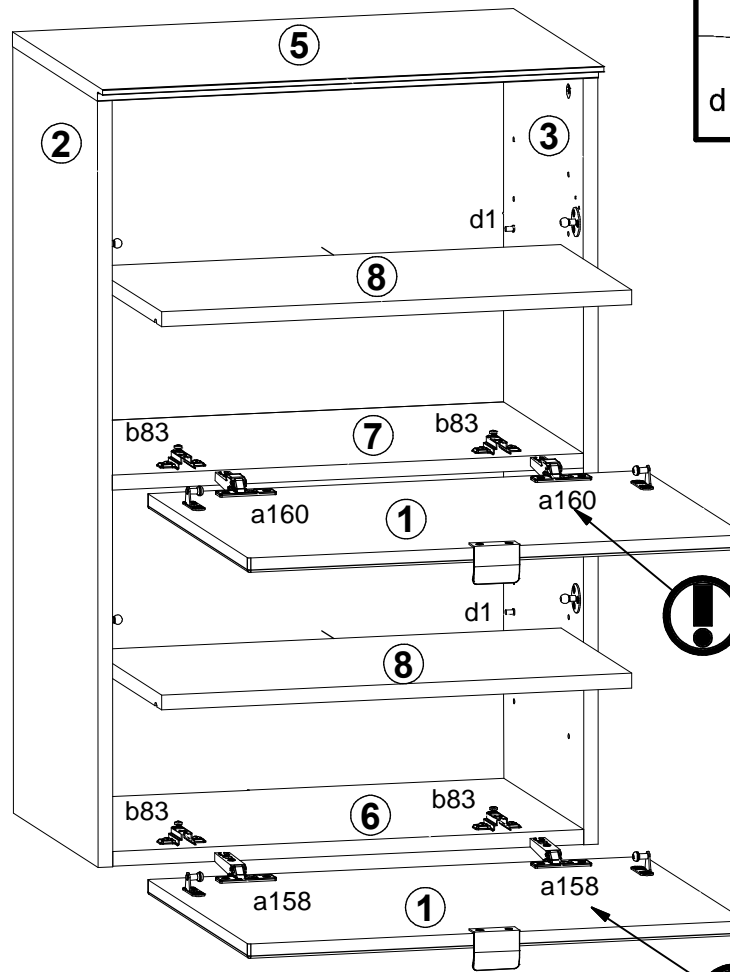

8

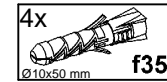
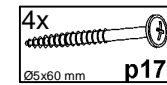
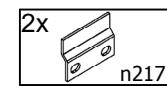
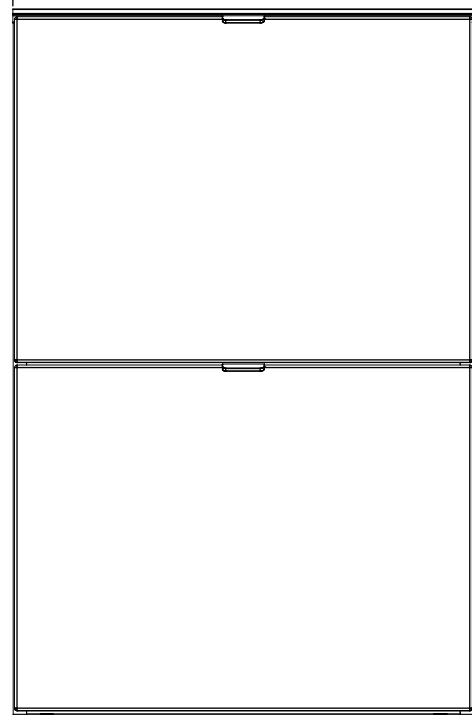
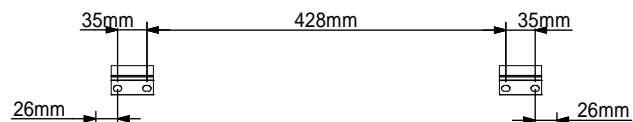
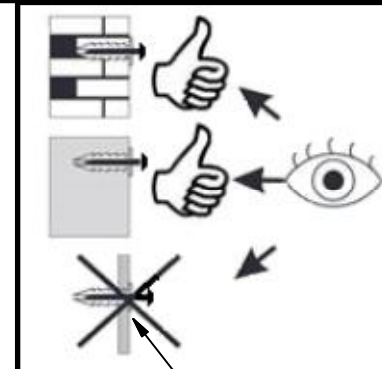
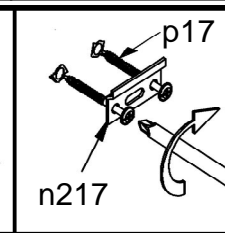
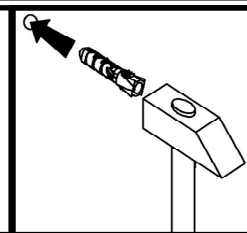
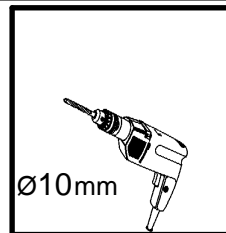
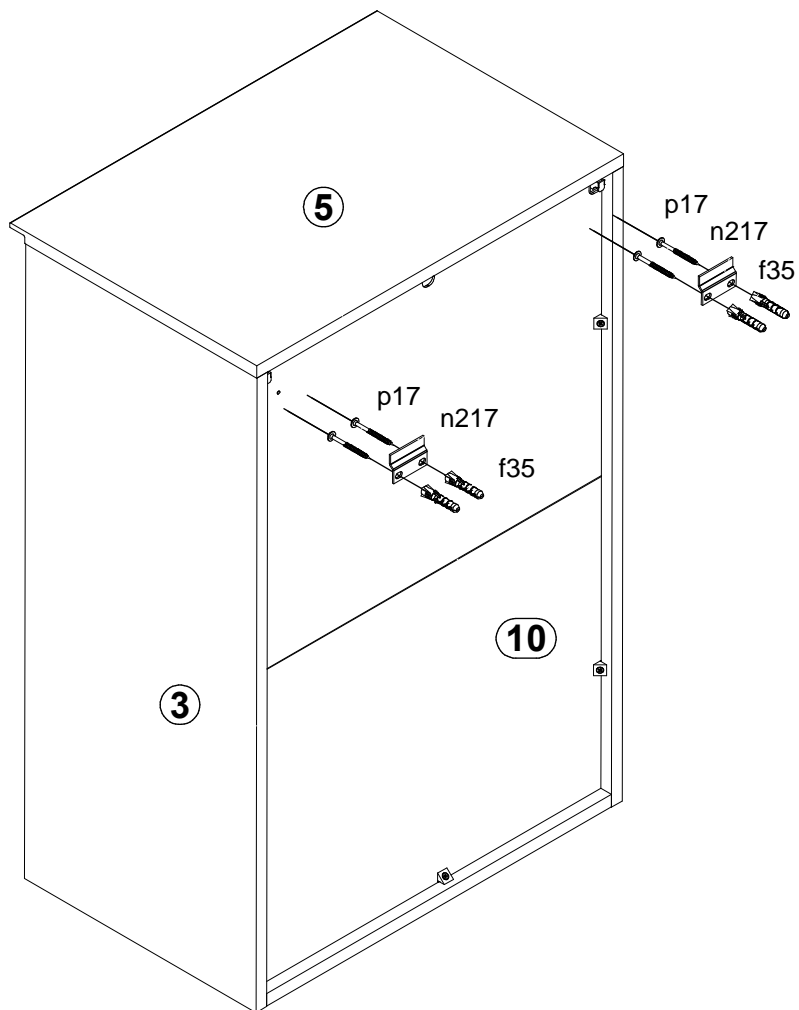

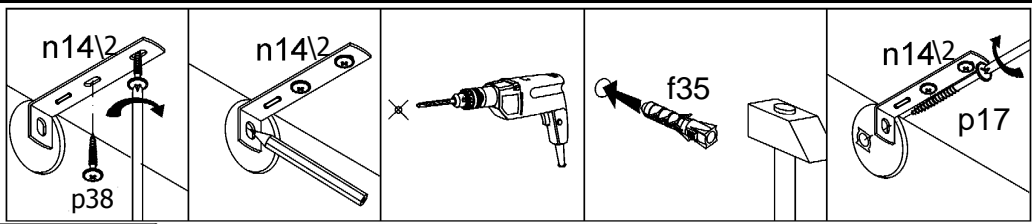

9

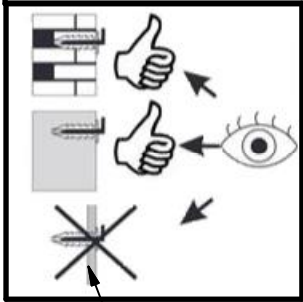

- 4x M4x12 mm j3
- 2x j45\2

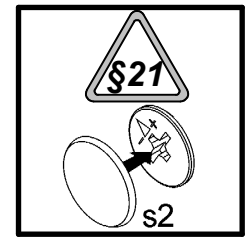
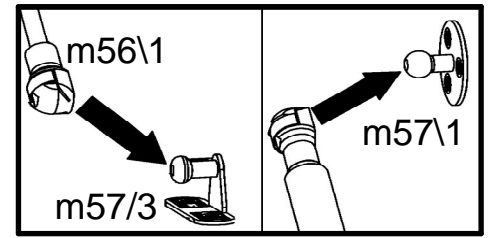
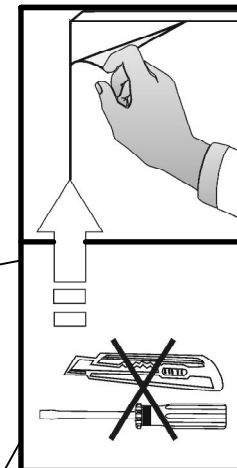
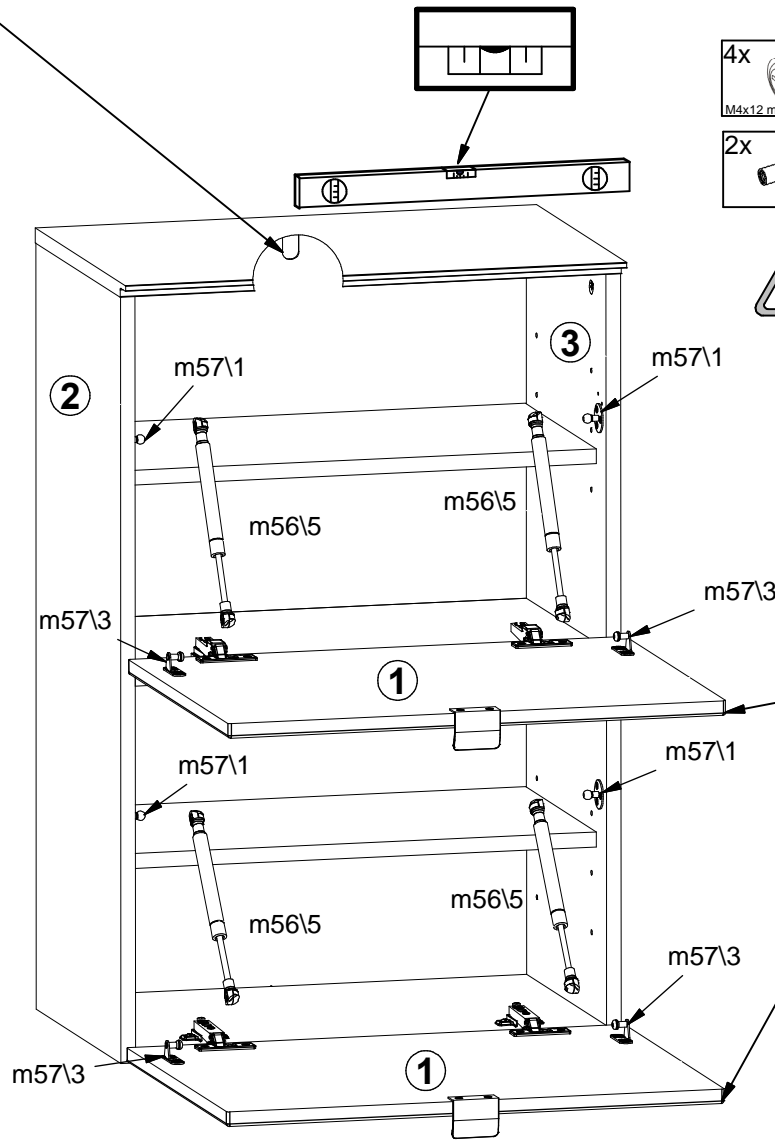
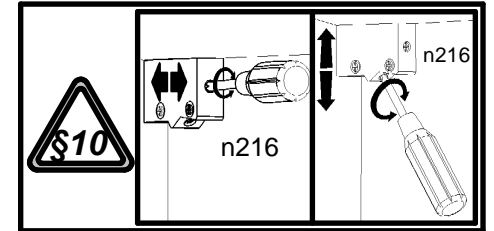
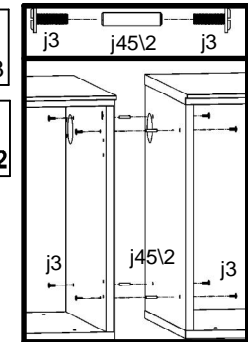

- 2x Ø3.5x16 mm p38

- 1x Ø10x50 mm f35

- 1x 88x21x15\1.5 n14\2

- 1x Ø5x60 mm p17

- 4x m56\1

- 8x Ø16 s2

