

88470.110

13-04-2017

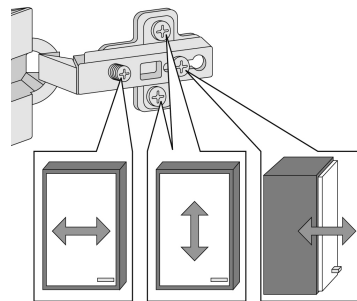

1 4 x 2802	2 4 x 2801	3 2 x 1601	4 2 x 1610	5 8 x 2861
6 4 x 2821	7 10 x 2862	8 2 x 1610	9 4 x 2812	10 4 x 2812
11 2 x 2840	12 2 x 2842	13 2 x 2843	14 4 x 2865	15 2 x 2855
16 4 x 2815	17 2 x 5254	18 2 x 2835	19 2 x 2829	20 4 x 2552
21 1 x 2863	0 10 20 30 40			

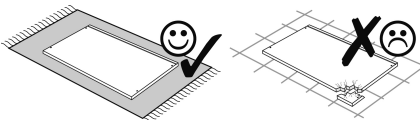
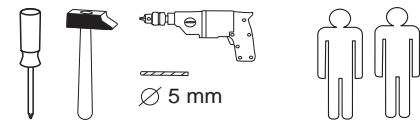
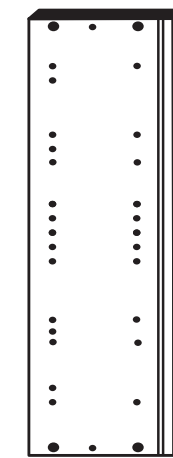

22 2 x

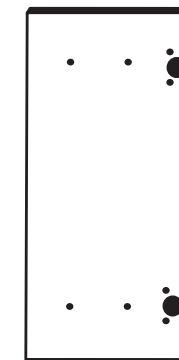

27 1 x



30 1 x

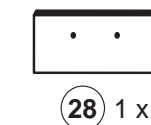

28 1 x



26 1 x

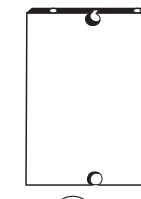

23 2 x



24 1 x

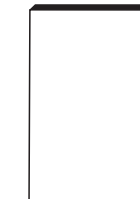

25 1 x

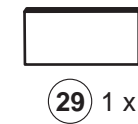

29 1 x

Das beigelegte Wandbefestigungsmaterial (Dübel und Schrauben) eignet sich nur für festes Mauerwerk (z.B.: Beton- oder Ziegelwände). Für andere Wandaufbauten sind eventuell Spezialdübel und andere Schrauben notwendig. Ziehen Sie gegebenenfalls eine Fachkraft zu Rate.

De begeleidende wandmontage hardware (pluggen en schroeven) is alleen geschikt voor massief metselwerk (bijvoorbeeld beton of bakstenen muren). Voor andere muur structuren zijn eventueel bijzondere ankerbouten en andere noodzakelijke. Draai indien nodig, een deskundige.

Приложенный материал для крепления к стене (дюбели и винты) пригоден только для жестких кладок (например, бетонные или кирпичные стены). Для других настенных конструкций необходимы смотря по обстоятельствам специальные дюбели и другие винты. При необходимости проконсультируйтесь у специалиста.

Le mur d'accompagnement matériel de montage (chevilles et les vis) ne convient que pour la maçonnerie solide (par exemple en béton ou des murs de briques). Pour les structures de mur d'autres sont peut-être spéciale boulons d'ancrage et d'autres nécessaires. Serrer le cas échéant, un expert.

Załączony materiał do mocowania do ściany (kolki rozprężne i wkręty) nadaje się tylko do ścian murowanych (np. z betonu lub cegiel). Do ścian wykonanych w innych technologiach konieczne być mogą specjalne kolki rozprężne i inne wkręty. W razie potrzeby skorzystaj z fachowej pomocy.

Il muro di accompagnamento hardware di montaggio (tasselli e viti) è adatto solo per muratura piena (ad esempio calcestruzzo o muratura). Per le altre strutture murarie sono forse speciali bulloni di ancoraggio e necessari di altri. Serrare se necessario, un esperto.

The accompanying wall mounting hardware (anchors and screws) is suitable only for solid masonry (eg concrete or brick walls). For other wall structures are possibly special anchor bolts and other necessary. Tighten if necessary, an expert.

Ekteki duvara sabit montaj malzemeleri (dübel ve vidalar), sadece sağlam duvarlar için (örnek: beton veya tuğla) elverişlidir. Başka duvarlar için özel dübeller ve farklı vidalar gerekebilir. Gerektiğinde bir bilene danışınız.

1

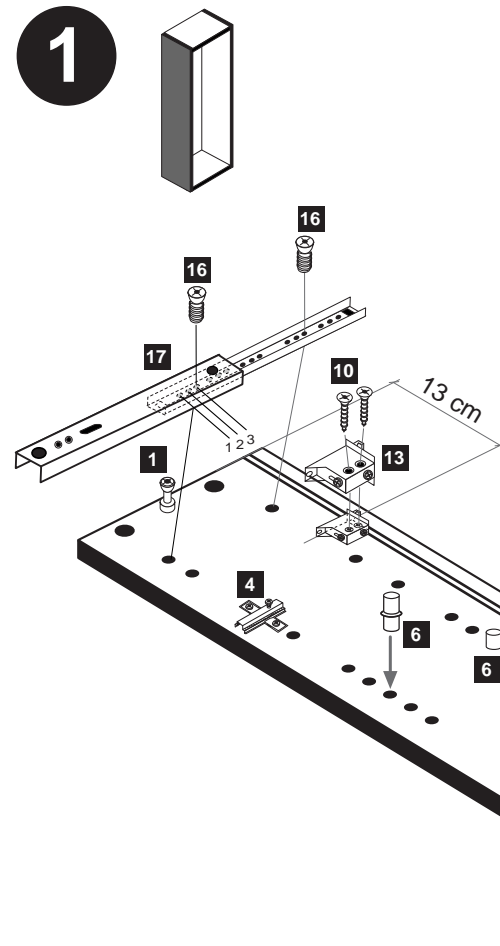

1 4 x 2802	4 2 x 1610	5/5 x 16 4 x 2821
10 4 x 2812	13 2 x 2843	6,3 x 11 4 x 2815
17 2 x 5254		

ACHTUNG!
Montagebeispiel Linksanschlag!
Soll die Tür rechts angeschlagen werden müssen die Kreuzmontageplatten 4 auf dem rechten Seitenteil (22) montiert werden.

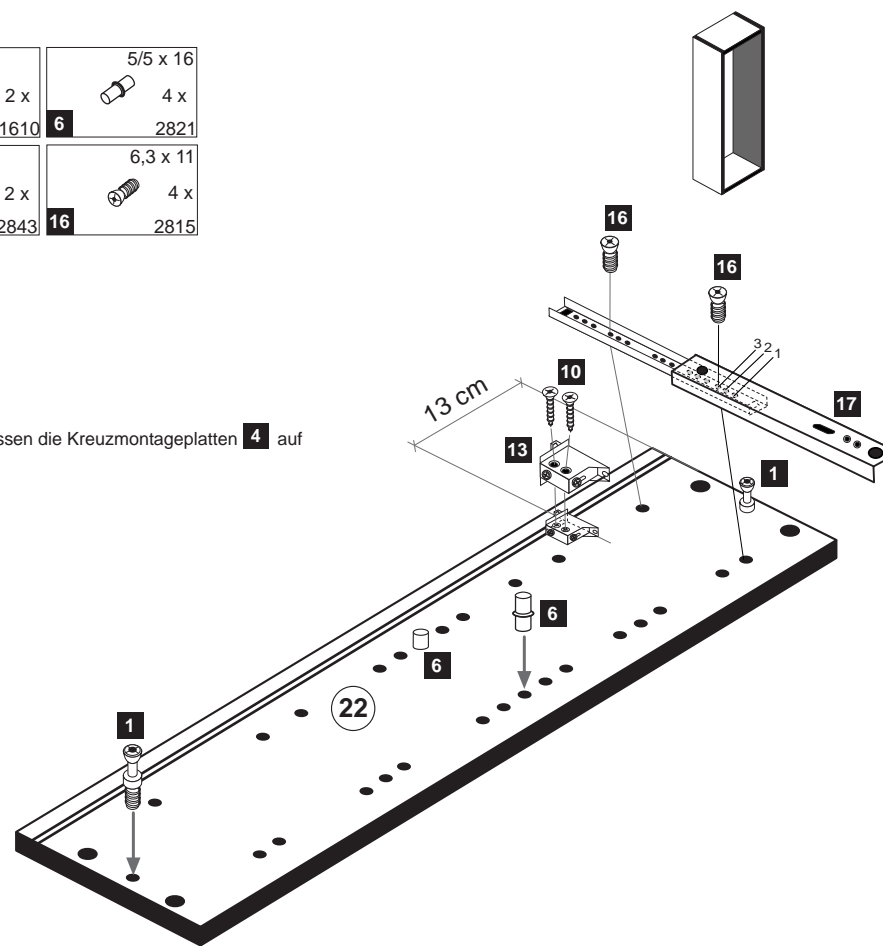

2

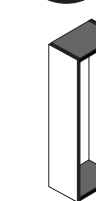

2 4 x 2801	5 8 x 30 8 x 2861	21 1 x 2863
------------------	----------------------------	-------------------

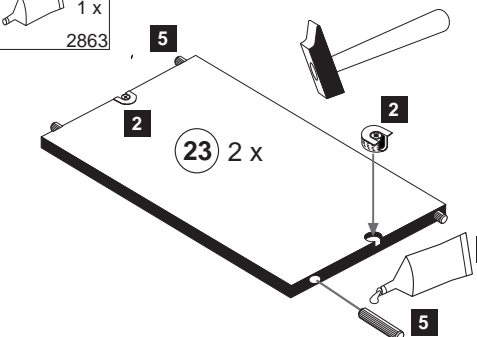

3

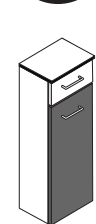

3 2 x 1601	14 2 x 2865
------------------	-------------------

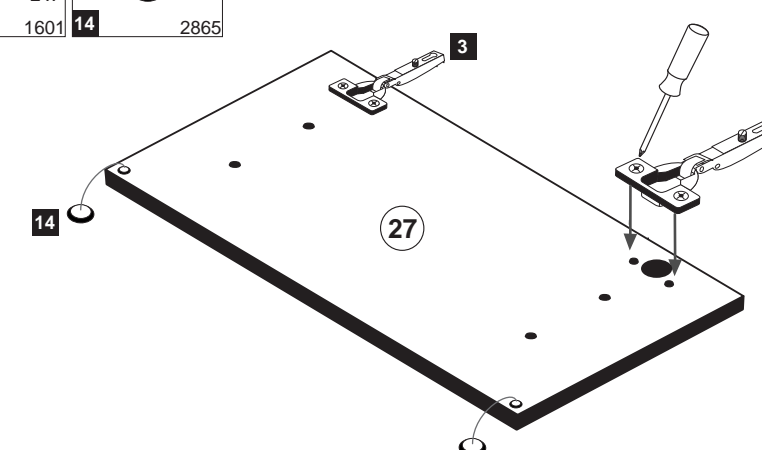

4

21 1 x 2863

20 min.

D Leim
GB Glue
NL Lijm
PL Klej
TR Tutkal
F Colle
I Colla

5

7 10 x 2862

6

20 4 x 2552

7

19 4 x 27 2 x 2829

1. \varnothing 5 mm

2.

8

1. \varnothing 5 mm

2.

9

8 1 x 9 4 x 22/25 2 x 14 2 x 2865 21 1 x 2863

10

ACHTUNG!
Montagebeispiel Linksanschlag!
Bei Rechtsanschlag andere Griffbohrung durchbohren!

2. \varnothing 5 mm

1.

11

18 4 x 9 2 x 2835

12

8 1 x 9 4 x 22/25 2 x 15 8 x 5 2 x 2855

13

11 5,8 x 55 2 x 2840 12 8 x 30 2 x 2842